



TURNCRAFT®

THE WORLD'S FINEST COLUMNS AND POSTS



WE TURN OUT *Quality*

A LITTLE ABOUT US

- Began manufacturing wood columns in 1963
- Added wood porch posts in 1969.
- The Architectural division was added in 1989.
- Introduced the Poly-Classic® Composite Products in 1994.
- PVC Craftsman's Products added in 2004.
- Introduced the DuraGlass™ Pultruded Products in 2006.

Architects and builders have chosen Turncraft columns because of our thoughtful design, exceptional materials, fine workmanship, superior assembly, and extensive selection. Precise historical research and authentic architectural specifications reflect our dedication to the quality you can expect from all of our products from in-stock columns to custom-built solutions.



TURNCRAFT PRODUCTS MADE IN THE U.S.A



DID YOU KNOW?

- All Turncraft products, wood and composite, are manufactured in the U.S.A. in our own factories.
- Our experienced craftsmen take extreme care and pride in the products we produce for our customers, all the way from making our own molds to the finished products.
- Turncraft provides the largest selection of products from any manufacturer. Period!
- All Turncraft products are designed to work together for perfectly matched columns regardless of the type of materials used.



Table of Contents

How to select	4-5
Styles and Design Characteristics	5-9
Poly-Classic® FRP Columns	10
Product Information	11
TimeSaver Cap and Base	12
Round Tapered Columns	14
Round Tapered Cap and Base	15
Round Non-tapered with Cap and Base	16
Square Non-tapered with Cap and Base	17
Ornamental Capitals	18
Poly-Classic® Durastone™	20
Product Information	21
Poly-Classic® DuraGlass™ columns	22
Product Information	23
Non-tapered Square with Cap and Base	24
Tapered Round with Cap and Base	25
Poly-Classic® Porch Posts	26
Product Information	27
Poly-Classic® Craftsman Columns	28
Craftsman Introduction and E-Z Lock	29
Tapered Shafts with Cap and Base	30
Non-tapered Shafts with Cap and Base	31
Pedestals and Newel Posts with Trim	32
Ornamental Capitals	33
Mix-N-Match Craftsman with Craftsman	34
Mix-N-Match Craftsman with FRP	35
Turncraft Architectural Series	36
Wood Species Available	37
Greek Doric and Tuscan Specifications	38
Roman Doric and Ionic Specifications	39
Roman Corinthian Specifications	40
Load Capacities and Plan Types	40
Ornamental Capitals	41
Colonial Columns	42
Product Information	43-44
Colonial Cap and Base	45
Ornamental Capitals	45
Square Wood Columns	46
Product Information	47
Wood Porch Posts	48
Product Information	49
Website	50
Quality at Every Turn	51

How to Select

Your Turncraft Column or Post (or which Turncraft column or post is right for you)

To determine which product is the best for your project, you'll want to consider several things: location, style, size, and plan type. Not all styles, sizes or plan types are made in all materials.

All Turncraft products (except the Craftsman Series) are manufactured whole and are designed to be load bearing. If you need to wrap an existing load support, all of our columns are able to be split in half at the factory or by the installer and re-assembled, or they can be split to be used as pilasters.

Craftsman Series columns are square, tapered or non-tapered, and are shipped KD (knocked-down) to be assembled around an existing load support. Craftsman Series pedestals are unique in that they may be used to add a pedestal look to any existing column, or combined with any of our other products to create a pedestal/column look.

I. Determine the location:

Where this product will be used – interior or exterior. All of our products are fine for interior use. Wood may be a more familiar material to work with, but all products can be installed with standard carpentry techniques and tools.

Best for exterior: Poly-Classic® products (low maintenance, lifetime warranty, waterproof), and Turncraft Architectural cedar columns. A large selection of styles are available. Poly-Classic® products require painting (except Poly-Classic® Porch Posts).

II. Determine the column line:

FRP Poly-Classic® FRP Column:

Fiberglass reinforced polymer are virtually maintenance-free. They are impervious to termites and carpenter ant attack as well as staining and decaying fungi. High-humidity environments have no effect on these non-porous, waterproof columns.



DST Poly-Classic® DuraStone™ Textured Paintable Column:

Available in all the same sizes as our paint grade FRP columns with Tuscan caps and bases. Paint any color to match any style.



DGL Poly-Classic® DuraGlass™ Column:

Resin-infused or pultruded fiberglass made from lightweight fiberglass, these columns are easy to cut, easy to install, and strong enough to carry heavy loads. DuraGlass™ columns are decay resistant and require little maintenance.



CRF Poly-Classic® Craftsman Series:

PVC-expanded cellular poly-vinyl-chloride are manufactured using expanded cellular PVC and can be trimmed, fastened and drilled with ordinary woodworking tools. Craftsman Series Columns are manufactured using our E-Z Lock Miter Joint that aids in assembly.



PCP Poly-Classic® Porch Post:

Galvanized steel square core and sturdy inserts at critical connection points. Constructed from seamless window grade vinyl with UV inhibitor. Delivered with matte white finish, but can be painted to match your project.

ARC *Turncraft Architectural:*

Exterior columns are usually made of cedar or pine. Cedar have a 10 year limited warranty, and pine has a 1 year limited warranty. Exterior wood products require painting. Turncraft Architectural also provides our most complete selection of styles and sizes, including interior stain grade columns.



COL *Colonial Column:*

Used for interior and exterior installations. Column shafts are manufactured from finger-joint pine, and unless factory primed, are immersion treated in Woodlife® 111. Ready to prime and paint.



SWC *Square Wood Column:*

Used for interior and exterior installations. Column shafts are manufactured from finger-joint pine, and unless factory primed, are immersion treated in Woodlife® 111. Ready to prime and paint.



WPP *Wood Porch Post:*

Made from select kiln-dried finger-jointed woods, and are precision moulded, glued with Type-I waterproof glue. Sanded and primed with special sealer applied to bottom of post for easy installation.



III. Determine the style.

Perhaps most important, is of course style. This includes the classical orders of architecture: Greek Doric, Tuscan, Roman Doric, Ionic and Corinthian, with the addition of our own Colonial style. All round columns are available plain or fluted (except DuraGlass™), and most square columns are available plain, fluted or with panels.

Greek Doric

Available in:

ARC *Architectural Wood*
(pages 36-41)

BRING HOME THE ELEGANCE OF THE PARTHENON.

The Greek Doric Order is unique among column styles with its absence of a base and astragal. The column height in ratio to its diameter varies greatly when viewed in antiquity: the architectural proportions can range from four to six diameters. Normally fluted, the Greek Doric has twenty flutes, with no fillets, so the flutes come to a peak (arris flutes). The depth of the flute is approximately one-sixth of the flute width. Greek Doric columns are most commonly recognized as those found on the Parthenon in Athens.

Turncraft.com





Tuscan

Available in:

FRP

Poly-Classic® FRP

(pages 10–19)

DST

DuraStone™ Textured FRP

(pages 20–21)

DGL

DuraGlass™ Fiberglass

(pages 22–25)

CRF

Craftsman PVC

(pages 28–35)

ARC

Architectural Wood

(pages 28–35)

SIMPLICITY GIVES YOUR DESIGN CENTER STAGE.

The distinguishing characteristic of the Tuscan Order is simplicity. Seldom fluted, the minimal mouldings and stylishly clean lines provide a robust appearance. When used in true architectural proportions, the height of the column, including cap and base, is seven diameters. Tuscan columns in antiquity are found on the Temple of Piety in Rome.



Roman Doric

Available in:

FRP

Poly-Classic® FRP

(pages 10–19)

ARC

Architectural Wood

(pages 28–35)

CLASSIC DESIGN REACHES NEW HEIGHTS.

The Roman Doric order features an increase of decorative moulding over the Tuscan Order. Vignola's Denticulated Doric Cap has a stepped, three-fillet support of the echinus instead of the single-fillet support of the Tuscan Order. The Doric base is similar to the Tuscan, but the addition of a bead above the torus moulding is an elegant embellishment. According to Vignola, the height of the Doric Column, including cap and base, should be eight diameters. Vignola Denticulated Doric is imitated closely from the Roman Theater of Marcellus.

Ionic

Available in:

FRP

Poly-Classic® FRP
(pages 10–19)

DST

DuraStone™ Textured FRP
(pages 20–21)

CRF

Craftsman PVC
(pages 28–35)

ARC

Architectural Wood
(pages 28–35)

ADDED EMBELLISHMENTS CREATE IMPRESSIVE SPACES. Embellishing the Ionic Order are ornate scrolls decorating the capital of the column. These scrolls derive their intriguing shape from the Nautilus shell. We include the Temple of Winds and Roman Doric Ornamental capitals, with their intricate designs, in our Ionic styles. Most commonly, Ionic columns incorporate twenty-four flutes separated by fillets that are about one-half the flute width. Customarily, the Ionic Order column height, including capital and base, is nine diameters. A prime example of the Ionic Order as it was used in Rome is the Temple of Fortuna Virilis.

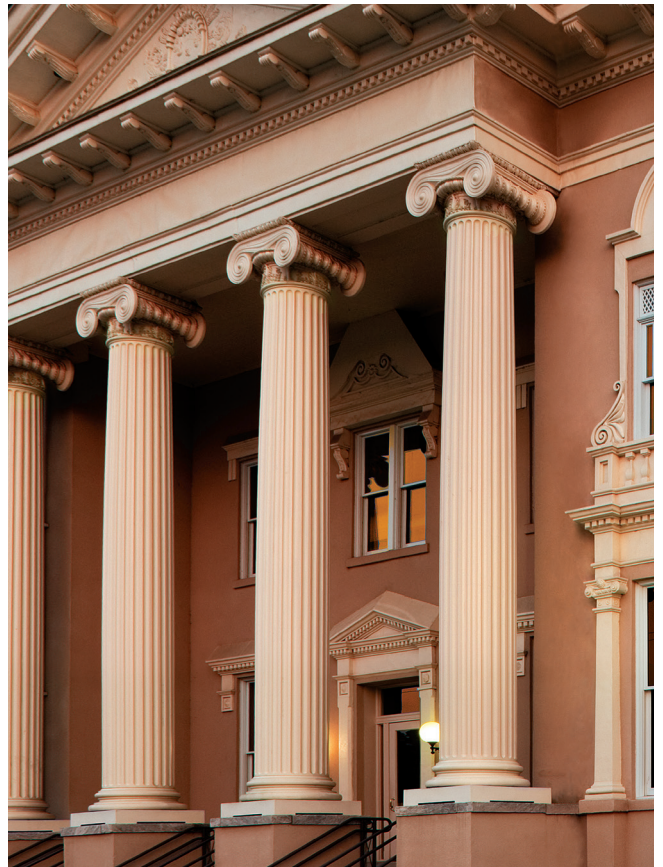

Corinthian

Available in:

FRP

Poly-Classic® FRP
(pages 10–19)

DST

DuraStone™ Textured FRP
(pages 20–21)

CRF

Craftsman PVC
(pages 28–35)

ARC

Architectural Wood
(pages 28–35)

MAKE IT THE CROWNING JEWEL OF YOUR PROJECT. Columns of the Corinthian Order are crowned with an inverted bell-shaped capital. The capital is richly adorned with Acanthus leaves. This column is almost always fluted. Like the Ionic, the Corinthian column exhibits twenty-four flutes and an Attic Base. The height of Corinthian columns, including capital and base, is ten diameters. This is a common Roman order that was used on the Temple of Mars Ultor.

Turncraft.com





Arts and Crafts

Available in:



Craftsman PVC

(pages 28–35)



DuraGlass™ Fiberglass

(pages 22–25)

THE STYLE IS TIMELESS. NOW THE COLUMN IS TOO.

Born out of the understated, practical tradition of the early 1900's Arts and Crafts movement, the square tapered column has become popular in modern adaptations of the Craftsman, Prairie, Bungalow, Country, and Mission style homes of today. Also available non-tapered, this timeless style is manufactured from expanded cellular PVC for quick, easy assembly and virtually maintenance-free performance! Now you can recapture the simple, honest artistry of yesterday's craftsman with today's most advanced materials and construction techniques.



DuraStone™ Texture

Available in:



DuraStone™ Textured FRP

(pages 20–21)

ANCIENT STYLE MADE WITH MODERN MATERIALS

Redesigned due to popular demand the DuraStone™ Textured Paintable Column gives you the look and feel of 2000 year old columns. From the factory in natural material finish you can match these textured columns to any style with your choice of paint color. Perfect for exterior or interior applications ...

Colonial Wood

Available in:

COL

Colonial Wood
(pages 42–45)

ELEGANT NEW WORLD ENHANCEMENTS FOR YOUR HOME.

As with many iconic Old World items, New World designers have taken the basic column concept and adorned it with a unique, more contemporary style. The Colonial style redefines the column with simplicity, yet retains the elegance desired to make bold statements for entryways and interiors. Available smooth or fluted, the entire line of ornamental capitals is also available for personalizing the column to fit any décor.



Porch Posts

Available in:

WPP

Porch Posts Wood
(pages 46–47)

PCP

Porch Posts Vinyl
(pages 26–27)

AN ALL-AMERICAN DECORATIVE TRADITION.

When a column would simply be too much, but a decorative touch is essential, a Porch Post from Turncraft would be the perfect choice. Often featured on Farmhouse and Country style houses with their spacious porches, and Victorian homes with their intricate details, the Colonial pattern is a traditional favorite. Porch Posts add charm and personality to walkways, landings, decks, and porches. There is nothing like the beauty of a Porch Post to add distinction and character to any home.

Turncraft.com





POLY-CLASSIC®

FRP *FRP Columns*

- STRONGEST COLUMN AVAILABLE
- LIMITED LIFETIME WARRANTY
- LOW MAINTENANCE
- READY TO PRIME AND PAINT
- WIDE ARRAY OF OPTIONS
- EXTERIOR OR INTERIOR USE
- CAN BE SPLIT FOR REASSEMBLY
- MADE WITH FLAME GUARD™

POLY-CLASSIC® FRP COLUMNS

Turncraft Poly-Classic® FRP Columns are the product of choice for homeowners and builders who demand beauty, value, and performance. Poly-Classic® FRP Columns are architecturally proportioned from rotocast fiberglass-reinforced polymer — the most advanced construction material in the world — so pound for pound they are stronger than concrete, steel, or aluminum.

NOW WITH FLAME GUARD

Poly-Classic® FRP Columns were the first fiberglass-reinforced polymer columns to achieve the distinction of passing an industry test (ASTME, 84-01) that measures the flame spread and smoke development of building components in a fire.

 Turncraft Poly-Classic® FRP Columns with Flame Guard set a new industry standard.		
	Flame Spread Index (FSI)	Smoke Developed Index (SDI)
Industry Standard for FRP Columns	70-85	900-1025
Turncraft Poly-Classic® Columns	15*	335**

*Achieving Class I Flame-Spread classification under 1997 uniform fire code. **Well below the allowable SDI index of 450.

LIMITED LIFETIME WARRANTY

Poly-Classic® FRP Columns are virtually maintenance-free. They are impervious to termite and carpenter ant attack as well as staining and decaying fungi. High-humidity environments have no effect on these non-porous, waterproof columns. All Turncraft Poly-Classic® Columns are covered by a limited lifetime warranty to the original purchaser. Warranty details are available from your distributor or our website-www.Turncraft.com.

PLAN TYPES

Poly-Classic® FRP Columns are available in the plan types below. Please specify when you order. (Fractional components shown are typical. Customer may specify actual returns, wall thicknesses, etc.)

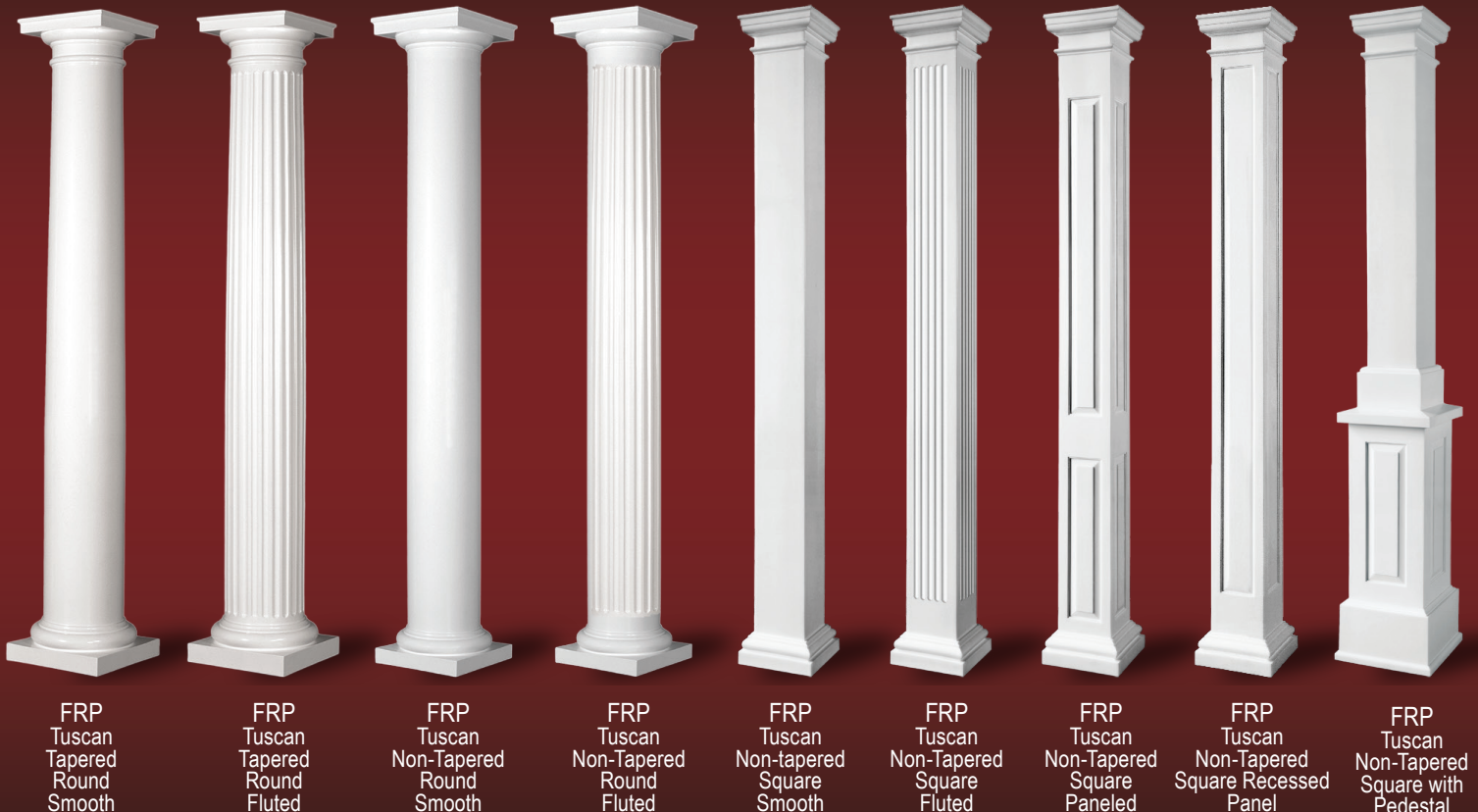
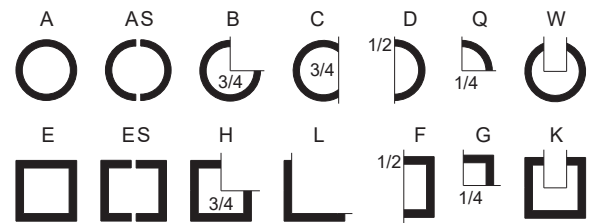

FRP Tuscan Tapered Round Smooth

FRP Tuscan Tapered Round Fluted

FRP Tuscan Non-Tapered Round Smooth

FRP Tuscan Non-Tapered Round Fluted

FRP Tuscan Non-tapered Square Smooth

FRP Tuscan Non-Tapered Square Fluted

FRP Tuscan Non-Tapered Square Paneled

FRP Tuscan Non-Tapered Square Recessed Panel

FRP Tuscan Non-Tapered Square with Pedestal

TURNCRAFT EXCLUSIVES PRODUCTS

TIMESAVER CAP AND BASE

New to the Turncraft product line, our 8" Square TimeSaver Cap and Base employs the same Quick-Fit installation pressure tabs as our round 8", 10", and 12" TimeSaver products. Our TimeSaver cap and base offers the easiest and quickest installation in the industry.



- Made out of fiber-reinforced recycled ABS (acrylonitrile butadiene styrene)
- Designed for use on round FRP columns in 8", 10", and 12" sizes
- Made with 95% recycled material
- Extremely strong and durable
- Self aligning with no fasteners
- Excellent paint adhesion
- Fast installation

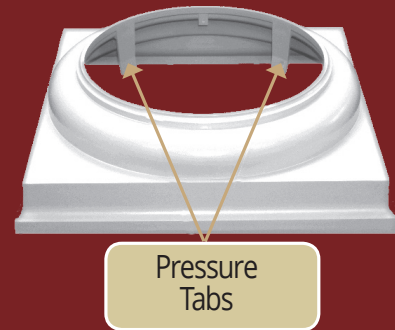

TIMESAVER RAILING ADAPTER BRACKET

Our TimeSaver railing adapter bracket solves the age old problem of attaching a railing system to the decorative base of a round column. Simply use one of these new brackets to make an attractive attachment to our 8", 10", and 12" round Tuscan bases. Brackets are available in two different heights, allowing them to be used with just about any railing system on the market.

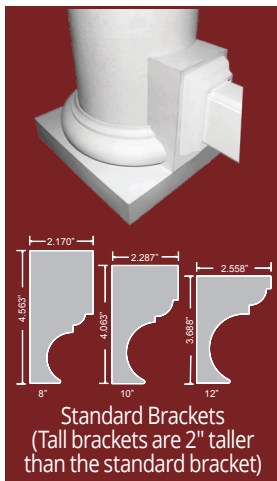

NEW! COPPER OR ALUMINUM FLASHING

Turncraft is now offering real flashing for our most popular sizes of columns - the 8", 10", and 12" round and square Poly-Classic® FRP columns with Tuscan caps. Flashing is available in either copper or aluminum. Flashing is 3/4" larger than abacus size, to be folded over the edges of the cap, held in place with construction adhesive (not supplied). Flashing for other sizes and styles of caps are available. Call for more information.

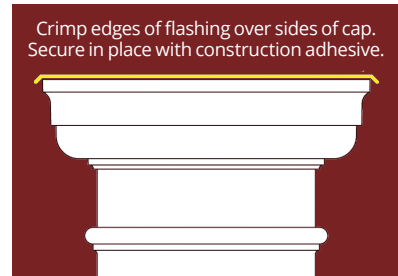

INSTALL KIT

For structural FRP columns, the install kit consists of 4 ABS brackets (2 for top of column and 2 for bottom) and fasteners required for standard installation. We recommend 2 kits for columns 16" and up: this will allow the installer to use 4 brackets at the top and bottom of the column. When installed, the cap and base will conceal these brackets and hardware.



SPLIT KIT

Each kit contains six nylon locking straps with 1/8" spacers and one quart (1.85 lb.) automotive body filler. For columns over 12 foot in height, two kits will be required per column. Turncraft recommends using an abrasive (Carborundum or similar) or carbide blade to trim the shaft. Split columns are not load bearing.



ROUND TAPERED AND NON-TAPERED COLUMNS

Available fluted and unfluted in a wide range of sizes. Flutes in most 8", 10", and 12" diameter tapered shafts are molded right into the shaft, providing consistent ionic fluting. All sizes can also be custom-fluted for specific opening heights, and adjusted for the cap and base chosen. When shafts are custom fluted, typically the flutes end 1" from the top of the base.

Tapered Round FRP Shafts Available Heights and Load Capacities														
Column Bottom Diameter ‡	5'	6'	8'	9'	10'	12'	14'	16'	18'	20'	22'	24'	Concentric Load *	Eccentric Load *
6"	√	√	√										6,000 lb.	6,000 lb.
8"	√	√	√●	√●	√●								10,000 lb.	6,600 lb.
10"	√	√	√●	√●	√●	√●							14,000 lb.	10,720 lb.
12"	√	√	√●	√●	√●	√●	√	√●					18,000 lb.	13,200 lb.
14"			√	√	√	√	√	√	√	√			20,000 lb.	11,520 lb.
16"	√	√	√	√	√	√	√	√	√	√			20,000 lb.	13,200 lb.
18"			√	√	√	√	√	√	√	√	√		20,000 lb.	9,040 lb.
20"		√	√		√	√	√	√	√	√			20,000 lb.	18,960 lb.
24"			√		√	√	√	√	√	√	√		20,000 lb.	13,200 lb.
30"	Available in DuraGlass™. Please see page 25.												25,000 lb.	n/a

Non-Tapered Round Shafts Available Heights and Load Capacities								
Column Bottom Diameter ‡	8'	10'	11'	12'	14'	15'	Concentric Load *	Eccentric Load *
8"	√	√					10,000 lb.	8,240 lb.
10"	√	√					14,000 lb.	11,520 lb.
12"	√	√		√			18,000 lb.	11,520 lb.
14"	√	√		√	√		20,000 lb.	18,120 lb.
16"	√	√					20,000 lb.	13,200 lb.
18"	√	√	√				20,000 lb.	9,040 lb.
20"	√	√	√				20,000 lb.	18,960 lb.
24"	√	√		√	√	√	20,000 lb.	13,200 lb.
30"	Available in DuraGlass™. Please see page 25.						25,000 lb.	n/a

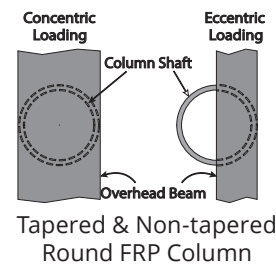

SQUARE NON-TAPERED COLUMNS

Available unfluted, fluted, recessed panel, or with a double raised panel. In addition, custom fluting is available. The astragal is molded into the shaft for consistent spacing and simplified installation.

Non-Tapered Square Shafts Available Heights and Load Capacities								
Column Bottom Width	8'	9'	10'	12'	14'	16'	Concentric Load *	Eccentric Load *
6"	√		√				6,000 lb.	6,000 lb.
8"	√●△◇	√●△	√●△◇				10,000 lb.	10,000 lb.
10"	√◇	√◇	√◇	√			12,800 lb.	12,800 lb.
12"	√	√	√	√	√	√	18,000 lb.	17,320 lb.
14"	√	√	√	√	√	√	20,000 lb.	17,320 lb.
16"	Available in DuraGlass™. Please see page 24.						20,000 lb.	n/a

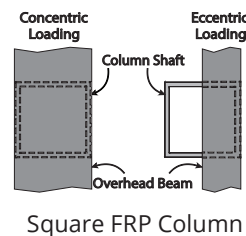

All Poly-Classic® FRP Columns are available with custom fluting.

√ Available unfluted.

● Available with standard flutes.

△ Available raised panel.

◇ Available with recessed panel.

‡ Actual shaft width may be smaller than nominal size shown.

* Load capacities are reduced when loads are not centered. Full documentation regarding eccentric load capacities can be found online at Turncraft.com/pdf/EccentricLoad.pdf and Turncraft.com/pdf/LoadAddendum.pdf.

Please refer to the online documentation regarding maximum eccentricity (beam offset from center) and other specifications.

FRP ROUND TAPERED COLUMN SPECIFICATIONS

Column nominal diameter	Shaft height (A)	Shaft bottom *		Shaft top *		Space available inside shaft		Shaft neck		Flute width (24 each)	Straight portion of shaft (unfluted) (B)	Straight portion of shaft (fluted) (B)	Smooth shaft before flutes (E)	
		Outside diameter (C)	Inside diameter (D)	Outside diameter (H)	Inside diameter (I)	For round post	For square post	Neck height † (G)	Astragal ring ‡ (F)					
6"	5'	5 1/16"	4 3/4"	4 1/16"	3 3/4"	3 3/8"	2 1/2"	3"	1/2"	1/2"	23 1/16"	n/a	n/a	
	6'													35 1/16"
	8'													59 1/16"
8"	5'	7 5/8"	6 3/4"	6 19/32"	5 1/2"	5 1/8"	3 1/2"	4 1/4"	1/2"	1 1/16"	14 1/16"	n/a	n/a	
	6'													26 1/16"
	8'													50 1/16"
	9'													62 1/16"
	10'													72 1/16"
10"	4'	9 11/16"	8 3/8"	8 9/16"	7 3/4"	7 3/8"	4 15/16"	5 1/8"	3/4"	7/8"	0	n/a	n/a	
	5'													10 11/16"
	6'													10 11/16"
	8'													34 11/16"
	9'													46 11/16"
	10'													58 11/16"
12"	5'	11 5/8"	10 3/4"	10 1/16"	9 1/4"	8 7/8"	6"	4 3/4"	3/4"	1"	0	n/a	n/a	
	6'													8 3/4"
	8'													32 3/4"
	9'													44 3/4"
	10'													56 3/4"
	12'													80 3/4"
	14'													62"
16'	86"													
14"	8'	13 1/2"	11 1/2"	11 1/16"	10 1/2"	10 1/8"	6 3/8"	6 3/4"	1"	1 1/4"	33 1/4"			
	9'													45 1/4"
	10'													57 1/4"
	12'													81 1/4"
	14'													57 1/4"
	16'													81 1/4"
	18'													105 1/4"
	20'													129 1/4"
16"	5'	15 7/16"	13 1/2"	13 1/8"	12"	11 5/8"	7 7/16"	7 3/8"	1"	1 7/16"	16 1/4"			
	6'													28 1/4"
	8'													18 1/2"
	9'													30 1/2"
	10'													42 1/2"
	12'													66 1/2"
	14'													27 1/4"
	16'													51 1/4"
	18'													75 1/4"
20'	99 1/4"													
18"	8'	17 3/8"	15"	14 5/16"	12 3/4"	12 3/8"	8 5/16"	7 7/8"	1"	1 1/2"	13 3/8"			
	9'													25 3/8"
	10'													37 3/8"
	12'													61 3/8"
	14'													85 3/8"
	16'													26 1/8"
	18'													50 1/8"
	20'													74 1/8"
	22'													98 1/8"
	24'													122 1/8"
20"	6'	19 3/8"	18"	16 5/16"	14 7/8"	14 1/2"	10"	9 3/16"	1 3/8"	1 11/16"	0			
	8'													22 1/4"
	10'													46 1/4"
	12'													70 1/4"
	14'													40 3/8"
	16'													64 3/8"
24"	8'	23 3/8"	22"	19 5/16"	18"	17 5/8"	12 3/16"	12"	1 5/8"	2 1/8"	8"			
	10'													32"
	12'													56"
	14'													24 13/16"
	16'													48 13/16"
	18'													72 13/16"
	20'													96 13/16"
22'	120 13/16"													
24'	144 13/16"													

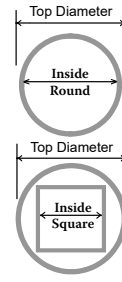

The "Space Available Inside Shaft" measurements are calculated at the top inside diameter (with ± 3/8" tolerance), when using Tuscan or Roman Doric caps. Fluted columns will have reduced tolerances.

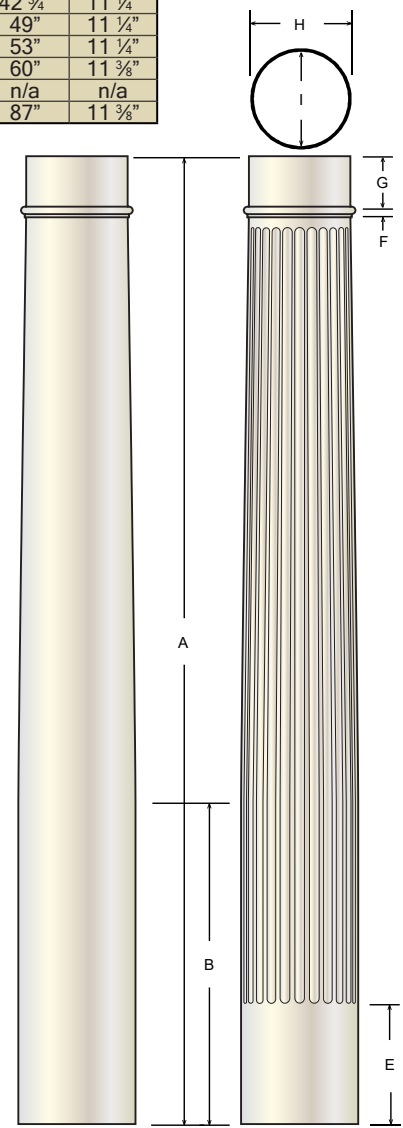

Refer to page 13 for Concentric and Eccentric load capacities.
 * Diameters may vary ± 1/8".
 † Neck Height is the distance from the top of the shaft to the top of the astragal ring, ± 1/8".
 ‡ Astragal ring is only the ring portion, and does not include the fillet and cove.

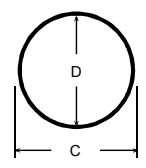

All caps, bases, and ornamental capitals are manufactured of low-maintenance materials. Materials for caps and bases will vary based on size and style. Standard Tuscan caps and bases for our 8", 10", and 12" diameter round tapered columns are our new TimeSaver ABS (recycled ABS with fiberglass reinforcement). Since these are molded products, specifications shown are ± 1/8", and subject to change without notice.

TUSCAN CAPS AND BASES

Column diameter	Tuscan Base					Tuscan Cap					Materials available †
	Plinth		Torus			Echinus	Abacus		Total height		
	(A)	(B)	(C)	(D)	(B-D)		(E)	(F)		(G)	
6"	8"	1 1/2"	1 1/4"	1/2"	3 1/4"	1"	1 1/16"	7 1/2"	2 1/16"	<u>P, D</u>	
8"	10 7/8"	1 7/8"	1 3/4"	5/8"	4 1/4"	1 5/16"	1 3/8"	9 7/8"	2 1 1/16"	<u>A, F, D, P</u>	
10"	13 1/2"	2 3/8"	2 1/8"	3/4"	5 1/4"	1 13/16"	1 3/4"	12 1/8"	3 3/16"	<u>A, F, D, P</u>	
12"	16 1/4"	2 3/4"	2 3/8"	7/8"	6"	1 7/8"	2"	14 5/8"	3 7/8"	<u>A, F, D, P</u>	
14"	18 5/8"	3 3/16"	3"	1"	7 5/16"	2 1/2"	2 5/16"	17"	4 15/16"	<u>P, D</u>	
16"	21 5/16"	3 7/8"	3 3/8"	1 1/8"	8 5/16"	2 3/4"	2 1 1/16"	19 1/8"	5 7/16"	<u>P, D</u>	
18"	24"	4 3/16"	4"	1 3/8"	9 9/16"	3"	2 15/16"	21 5/16"	5 15/16"	<u>P, D</u>	
20"	27"	4 3/4"	4 1/16"	1 3/4"	10 9/16"	3 1/2"	3 7/16"	24 1/4"	6 9/16"	<u>P, D</u>	
24"	32 1/2"	5 3/4"	5 1/4"	2 1/4"	13 1/4"	3 5/16"	4 1/8"	28 3/4"	7 7/16"	<u>P, D</u>	

† A-ABS TimeSaver, F-FRP, D-DuraStone™, P-Polyurethane cap with FRP base; standard material is underlined

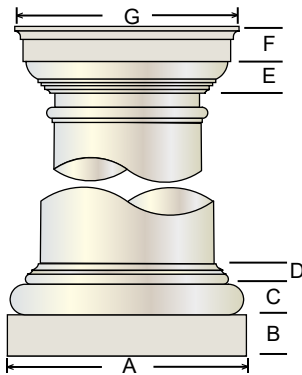
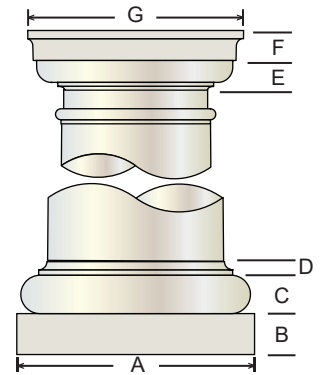

ROMAN DORIC CAPS

Column diameter	Roman Doric Base †					Roman Doric Cap †				
	Plinth		Torus			Echinus	Abacus		Total height	
	(A)	(B)	(C)	(D)	(B-D)		(E)	(F)		(G)
6"	7 31/32"	1 1/2"	1"	3/4"	3 1/4"	1"	1 1/4"	8"	2 1/4"	
8"	10 7/8"	1 7/8"	1 1/16"	15/16"	4 1/4"	1 7/16"	1 1/2"	10 1/4"	2 15/16"	
10"	13 1/2"	2 3/8"	1 3/4"	1 1/4"	5 3/8"	1 7/8"	1 3/4"	13"	3 5/8"	
12"	16 1/8"	2 3/4"	2 1/16"	1 3/8"	6 3/16"	2 1/8"	2 3/8"	15 1/8"	4 1/2"	
14"	18 3/4"	3 3/8"	2 3/8"	1 5/8"	7 3/8"	2 1 1/16"	2 3/4"	17 13/16"	5 9/16"	
16"	21 1/2"	3 7/8"	2 7/8"	2"	8 3/4"	3 3/16"	3 1/8"	20 5/16"	6 5/16"	
18"	24"	4 1/8"	3 5/16"	2 3/8"	9 13/16"	3 1/2"	3 1/16"	22 7/16"	7 1/16"	

† Bases are FRP, caps are polyurethane. Only the bases are available in DuraStone™-not the caps.

OPTIONAL ATTIC BASES

Column diameter	Plinth		Torus				Total height
	(A)	(B)	(C)	(D)	(E)	(F)	
6"	8"	1"	3/4"	3/4"	1/2"	1/2"	3 1/2"
8"	10 7/8"	1 7/8"	1 1/8"	7/8"	3/4"	1/2"	5 1/8"
10"	13 1/2"	2 3/8"	1 1/4"	1 1/8"	7/8"	5/8"	6 1/4"
12"	16 1/8"	2 3/4"	1 1/2"	1 3/8"	1"	5/8"	7 1/4"
14"	18 1/2"	3 5/16"	1 3/4"	1 5/8"	1 1/4"	1 1/16"	8 2 1/32"
16"	21 3/16"	3 3/4"	2 1/8"	1 7/8"	1 1/2"	13/16"	10 1/8"
18"	23 15/16"	4 1/4"	2 5/16"	2 1/8"	1 7/16"	1 1/8"	11 1/4"
20"	27 1/16"	4 3/4"	2 1/16"	2 3/8"	1 3/4"	1 7/16"	13"
24"	32 1/2"	5 3/4"	3 5/16"	2 13/16"	2 1/8"	1 3/4"	15 3/4"

Attic bases are FRP. Also available in DuraStone™.

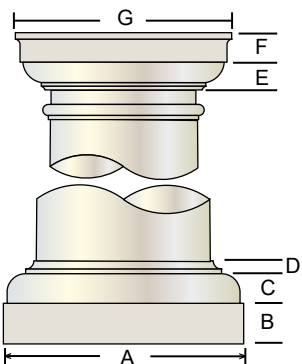
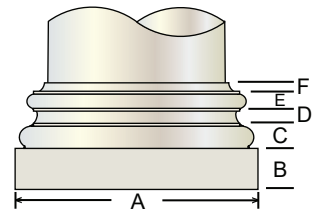

BUILDERS SERIES CAPS AND BASES

Column diameter	Builders Series Base †					Builders Series Cap †				
	Plinth		Torus			Echinus	Abacus		Total height	
	(A)	(B)	(C)	(D)	(B-D)		(E)	(F)		(G)
8"	10 7/8"	1 7/8"	1 1/4"	5/8"	3 3/4"	1 1/4"	1 1/4"	9 7/16"	2 1/2"	
10"	13 1/2"	2 3/8"	1 5/8"	9/16"	4 9/16"	1 13/16"	1 3/4"	12 3/16"	3 9/16"	
12"	16 1/4"	2 3/4"	2"	7/8"	5 5/8"	1 7/8"	2"	14 5/8"	3 7/8"	

† Cap and base are polystyrene (with foam core). Not available in DuraStone™.

POLY-CLASSIC® SHAFTS FOR ROUND NON-TAPERED FRP COLUMNS

Standard FRP column shafts are the same height as the listed size. Tuscan caps and bases and Attic bases go around the shaft, and do not affect the overall height. Ornamental capitals are not typically available for non-tapered round shafts.

Column nominal diameter	Shaft height (A)	Shaft diameters *		Space available inside shaft		Flute width (24 each)	Concentric Load	Eccentric Load
		Outside diameter (B)	Inside diameter (C)	For round post	For square post			
8"	8'	7 5/8"	6 3/4"	6 3/8"	4 1/2"	1 1/16"	10,000 lb.	6,600 lb.
	10'							
10"	8'	9 1 1/16"	8 3/8"	8"	5 5/8"	7/8"	14,000 lb.	10,720 lb.
	10'							
12"	8'	11 5/8"	10 3/4"	10 3/8"	7 5/16"	1"	18,000 lb.	13,200 lb.
	10'							
	12'							
14"	8'	13 1/2"	11 1/2"	11 1/8"	7 7/8"	1 5/16"	20,000 lb.	11,520 lb.
	10'							
	12'							
	14'							
16"	8'	15 7/16"	13 1/2"	13"	9 3/16"	1 1/2"	20,000 lb.	13,200 lb.
	10'							
18"	8'	17 3/8"	15"	14 1/2"	10 1/4"	1 1 1/16"	20,000 lb.	9,040 lb.
	10'							
	11'							
20"	8'	19 3/8"	18"	16 1/2"	11 5/8"	1 7/8"	20,000 lb.	18,960 lb.
	10'							
	11'							
24"	8'	23 3/8"	21 1/4" (top ID)	19 1/2"	13 3/4"	2 5/16"	20,000 lb.	13,200 lb.
	10'							
	12'							
	14'							
	15'							

* Diameters may vary ± 1/8".

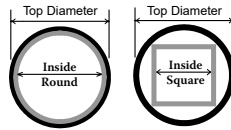

The "Space Available Inside Shaft" measurements are calculated at the top inside diameter (with ± 3/8" tolerance) when using Tuscan or Roman Doric caps. Fluted columns may have reduced tolerances.

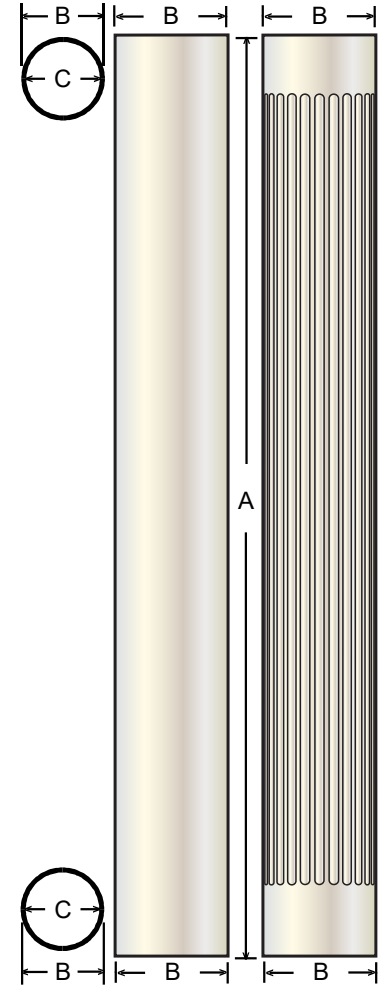

TUSCAN CAPS AND BASES

Column diameter	Tuscan Base						Tuscan Cap				
	Plinth		Torus		Total height (B-D)	Materials available *	Echinus (E)	Abacus		Total height (E-F)	Materials available *
	(A)	(B)	(C)	(D)			(E)	(F)	(G)	(E-F)	
8"	10 7/8"	1 1/8"	1 3/4"	5/8"	4 1/4"	A, F	1 13/16"	1 3/4"	12 1/8"	3 9/16"	P, D
10"	13 1/2"	2 3/8"	2 1/8"	3/4"	5 1/4"	A, F	1 7/8"	2"	14 5/8"	3 7/8"	P, D
12"	16 1/4"	2 3/4"	2 3/8"	7/8"	6"	A, F	2 1/2"	2 5/16"	17"	4 13/16"	P, D
14"	18 5/8"	3 5/16"	3"	1"	7 5/16"	F	2 3/4"	2 1 1/16"	19 1/8"	5 1/16"	P, D
16"	21 5/16"	3 7/8"	3 3/8"	1 1/8"	8 5/16"	F	3"	2 15/16"	21 5/16"	5 15/16"	P, D
18"	24"	4 3/16"	4"	1 3/8"	9 9/16"	F	3 1/8"	3 1/16"	24 1/4"	6 9/16"	P, D
20"	27"	4 3/4"	4 1/16"	1 3/4"	10 9/16"	F	3 3/16"	4 1/8"	28 3/4"	7 5/16"	P, D
24"	32 1/2"	5 3/4"	5 1/4"	2 1/4"	13 1/4"	F	3 5/16"	4 1/8"	32 1/2"	7 1/16"	P, D

* A-ABS, F-FRP, D-DuraStone™, P-Polyurethane; standard material is underlined.

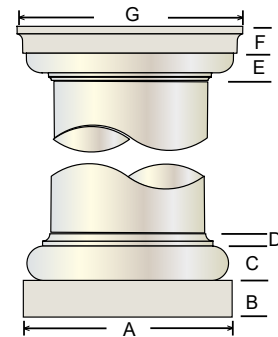

OPTIONAL ATTIC BASES

Column diameter	Attic Base						Total height (B-F)
	Plinth		Torus				
	(A)	(B)	(C)	(D)	(E)	(F)	
8"	10 7/8"	1 1/8"	1 1/8"	7/8"	3/4"	1/2"	5 1/8"
10"	13 1/2"	2 3/8"	1 1/4"	1 1/8"	7/8"	5/8"	6 1/4"
12"	16 1/8"	2 3/4"	1 1/2"	1 3/8"	1"	5/8"	7 1/4"
14"	18 1/2"	3 5/16"	1 3/4"	1 5/8"	1 1/4"	1 1/16"	8 5/8"
16"	21 3/16"	3 3/4"	2 1/8"	1 7/8"	1 1/2"	1 3/16"	10 1/8"
18"	23 15/16"	4 1/4"	2 5/16"	2 1/8"	1 1/16"	1 1/8"	11 1/4"
20"	27 1/16"	4 3/4"	2 1 1/16"	2 3/8"	1 3/4"	1 1/16"	13"
24"	32 1/2"	5 3/4"	3 5/16"	2 1 3/16"	2 1/8"	1 3/4"	15 3/4"

Attic bases are FRP. Also available in DuraStone™.

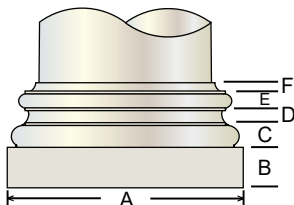

POLY-CLASSIC® SQUARE SHAFTS FOR NON-TAPERED FRP COLUMNS

Column nominal width	Shaft height	Outside width (B)	Inside width * (C)	Neck height † (E)	Astragal ring ‡ (D)	Flute width (20 each)	Space available inside shaft *	Concentric Load	Eccentric Load
6"	8'	5 7/8"	4 3/4"	3 5/8"	3/4"	1/2"	4 1/2"	6,000 lb.	6,000 lb.
	10'								
8"	8'	7 7/8"	5 3/4"	4 1/2"	3/4"	1 1/16"	5 1/2"	10,000 lb.	10,000 lb.
	10'								
10"	8'	9 7/8"	8 3/4"	5 1/16"	3/4"	7/8"	8 1/2"	12,800 lb.	12,800 lb.
	9'								
	10'								
12"	8'	11 7/8"	10 3/4"	4 1/2"	3/4"	1"	10 1/2"	18,000 lb.	17,320 lb.
	9'								
	10'								
	12'								
	14'								
14"	8'	13 7/8"	12 3/4"	7"	1"	1 1/4"	12 1/2"	20,000 lb.	17,320 lb.
	9'								
	10'								
	12'								
	14'								

Fluted column (stock)				Raised panel columns		
Column nominal width	Shaft height	Bottom of shaft before flutes (F)	Flute length (G)	Bottom of shaft before panel (H)	Bottom panel height (I)	Top panel height (J)
8"	8'	10 15/16"	77 13/16"	9 5/8"	22 15/16"	45 7/8"
	9'	10 15/16"	89 13/16"	9 5/8"	26 15/16"	53 7/8"
	10'	22 15/16"	89 13/16"	21 5/8"	26 15/16"	53 7/8"

Recessed panel columns					
Column nominal width	Shaft height	Base to panel * (K)	Panel height (L)	Panel to top height (M)	Panel width (N)
8"	8'	11 3/8"	76 3/4"	7 5/8"	4 7/8"
	9'	11 3/8"	88 3/4"	7 5/8"	4 7/8"
	10'	11 3/8"	100 3/4"	7 5/8"	4 7/8"
10"	8'	14 1/2"	73 11/16"	8 3/16"	6 7/8"
	9'	14 1/2"	85 11/16"	8 3/16"	6 7/8"
	10'	14 1/2"	97 11/16"	8 3/16"	6 7/8"

* For 8" size, stock fluted shaft value is shown. Paneled and plain shafts are typically 1/2" to 1" greater.

† Neck Height is the distance from the top of the shaft to the top of the astragal ring (±1/8").

‡ Astragal ring is only the ring portion, and does not include the fillet and cove

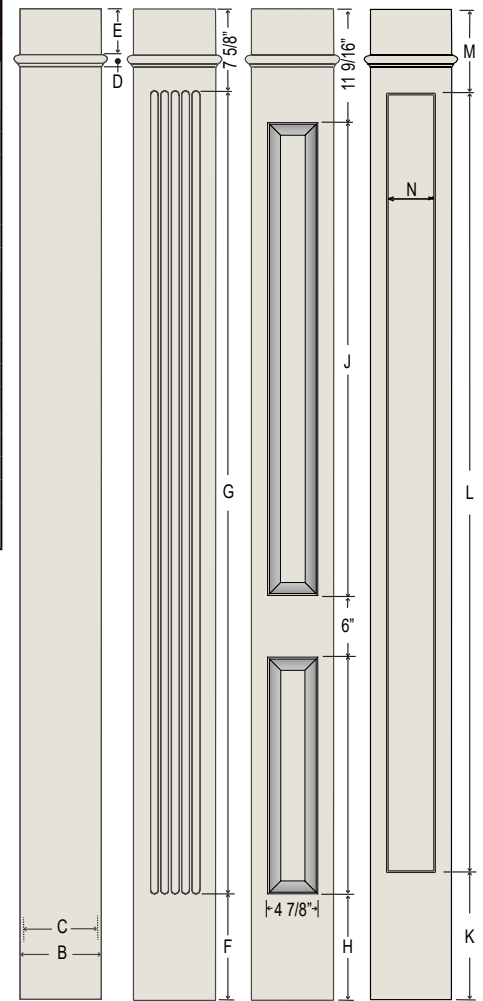

TUSCAN CAPS AND BASES

Column width	Tuscan Base *					Tuscan Cap *			
	Plinth (A, B)		Torus (C, D)		Total height (B-D)	Echinus (E)	Abacus (F, G)		Total height (E-F)
6"	8"	1 1/2"	1 1/4"	1/2"	3 1/4"	1"	1 1/16"	8 3/16"	2 1/16"
8"	11 3/8"	1 7/8"	1 3/4"	5/8"	4 1/4"	1 5/16"	1 7/16"	11 1/4"	2 3/4"
10"	13 1/2"	2 3/8"	2 1/8"	3/4"	5 1/4"	1 13/16"	1 3/4"	13 1/4"	3 9/16"
12"	17"	2 3/4"	2 3/8"	7/8"	6"	1 7/8"	2"	17 1/4"	3 7/8"
14"	18 13/16"	3 3/8"	2 15/16"	1 1/16"	7 3/8"	2 1/2"	2 5/16"	18 11/16"	4 13/16"

* 14" bases are FRP, other cap and base are polyurethane. Also available in DuraStone™.

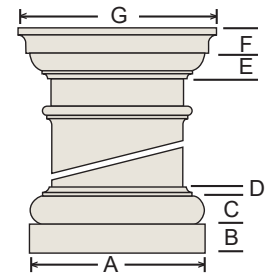

OPTIONAL ATTIC BASES

Column width	Plinth (A, B)		Torus (C, D, E)			Total height (B-F)	
	6"	8"	1"	3/4"	3/4"	1/2"	1/2"
8"	10 7/8"	1 7/8"	1 1/8"	7/8"	3/4"	1/2"	5 1/8"
10"	13 1/2"	2 3/8"	1 1/4"	1 1/8"	7/8"	5/8"	6 1/4"
12"	17"	2 3/4"	1 1/2"	1 3/8"	1"	5/8"	7 1/4"
14"	18 1/2"	3 5/16"	1 3/4"	1 5/8"	1 1/4"	11/16"	8 5/8"

Attic bases are FRP. Also available in DuraStone™.

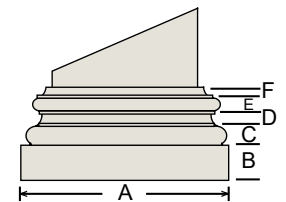

PEDESTAL BASE FOR SQUARE FRP COLUMNS

Column width	Bottom width (A)	Total height (B)	Bottom (C)	Center (D)	Platform (E)	Top (F)	Top width (G)
8"	15"	42 3/8"	8 11/16"	25 7/8"	2 1/8"	5 11/16"	8 1/4"

* Pedestal bases are FRP. Also available in DuraStone™. Use with Tuscan cap (above) or Ornamental Capitals.

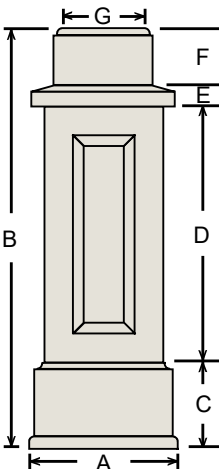

CAPITALS FOR FRP ROUND TAPERED COLUMNS

Our standard round capitals install on top of the column and are set on the fillet or the neckring. Capitals are either load-bearing or will include a load-bearing plug.



Empire



Empire with Necking



Greek Angular Ionic



Greek Erectheum



Greek Erectheum with Necking



Modern Composite



Roman Corinthian



Roman Doric Ornamental



Roman Ionic



Scamozzi



Temple of Winds

Shaft nominal bottom diameter	Empire				Empire with Necking				Greek Angular Ionic				Greek Erectheum			
	Capital height	Abacus width	Scroll width	Height adjust *	Capital height	Abacus width	Scroll width	Height adjust *	Capital height	Abacus width	Scroll width	Height adjust *	Capital height	Abacus width	Scroll width	Height adjust *
6"	3 3/8"	9"	8 3/4"	-1"	6 7/8"	9"	8 3/4"	+3 1/4"	3 5/8"	9 1/4"	9"	-1/2"	3 1/4"	6 3/4"	8 1/2"	-7/8"
8"	3 3/4"	10"	9"	-1"	7 3/4"	10"	9"	+3 1/2"	3 3/4"	9 1/2"	9"	-1"	3 3/4"	7 3/4"	11 3/4"	-1"
10"	5 1/2"	16"	13 1/2"	-3/8"	10"	13 1/2"	12 1/4"	+4 7/8"	5 3/8"	14 1/4"	13 1/4"	-1/2"	5 1/2"	12"	17 1/2"	-3/8"
12"	6 1/4"	18"	17"	+3/4"	11"	18"	17"	+6 1/4"	6"	17 1/4"	17"	+1/2"	6 1/4"	14 1/2"	21"	+3/4"
14"	7 1/4"	20 1/4"	19 1/2"	-3/4"	14 1/2"	20 1/2"	19 1/2"	+7 1/2"	7 1/4"	20 3/4"	19 1/4"	-3/4"	7"	15"	21"	-1"
16"	8 3/4"	23"	19 1/2"	+5/8"	17"	23"	19 1/2"	+9 7/8"	8 3/8"	20 1/2"	19 1/2"	+1/4"	9"	17 1/2"	26"	+7/8"
18"	10"	30 3/4"	26 1/4"	+3/4"	15"	32"	26 1/4"	+6 3/4"	9 3/4"	24 1/4"	19 3/4"	+1/2"	10 1/2"	22"	29"	+1 1/4"
20"	11 1/4"	34"	28"	+1 1/8"	17 1/4"	34"	28"	+8 1/2"	11"	29 3/4"	28"	+7/8"	11"	26"	36"	+7/8"
24"	12 3/4"	35 1/2"	35"	-1 1/8"	19"	35 1/2"	35"	+6 3/4"	12 3/4"	35"	34 1/2"	-1 1/8"	13"	30 1/2"	43"	-7/8"
30"	n/a				n/a				n/a				15"	31"	45 1/2"	TBD

Shaft nominal bottom diameter	Greek Erectheum with Necking				Modern Composite			Roman Corinthian			Roman Doric Ornamental			
	Capital Height	Abacus width	Scroll width	Height adjust *	Capital height	Abacus width	Height adjust *	Capital height	Abacus width	Height adjust *	Capital height	Abacus width	Scroll width	Height adjust *
6"	5 3/4"	7 3/4"	11 3/4"	+2 1/2"	7"	8"	+3 3/8"	7"	9 1/2"	+3 3/8"	4"	8 3/4"	n/a	+1/8"
8"	7 1/2"	10 1/2"	15"	+3 1/4"	8 1/2"	10 3/4"	+4 1/4"	10 1/4"	12 3/4"	+6"	6"	13 1/2"	n/a	+1 1/4"
10"	8 1/2"	12"	17 1/4"	+3 3/8"	12 1/4"	16 1/2"	+7 1/8"	13 7/8"	17 3/4"	+8 3/4"	7"	16 1/4"	n/a	+1 1/8"
12"	9 1/2"	14 1/2"	21"	+4 3/4"	14 1/2"	19"	+9 3/4"	15 1/2"	18 1/2"	+10 3/4"	7"	16 1/4"	n/a	+1 1/2"
14"	11 1/4"	15"	21"	+4 1/4"	17"	20"	+10"	17"	22"	+10"	9"	21"	n/a	+1 1/4"
16"	13 1/2"	17 1/2"	26"	+6 3/8"	n/a			20"	27"	+12 7/8"	10 1/2"	24"	n/a	+2 1/8"
18"	15"	22 1/2"	29"	+6 3/4"	22 1/2"	25"	+14 1/4"	23"	32 1/2"	+14 3/4"	12 1/2"	28"	n/a	+3 5/8"
20"	17"	26"	36"	+8 1/4"	22 1/2"	25"	+13 3/4"	24 3/4"	38 1/2"	+16"	12 1/2"	28"	24"	+2 3/8"
24"	19"	30 1/2"	43"	+6 3/4"	n/a			27 3/4"	42"	+15 1/2"	n/a			
30"	24 3/4"	31"	45 1/2"	TBD	n/a			37 1/2"	46 1/2"	n/a	n/a			

Shaft nominal bottom diameter	Roman Ionic				Scamozzi				Temple of Winds		
	Capital height	Abacus width	Scroll width	Height adjust *	Capital height	Abacus width	Scroll width	Height adjust *	Capital height	Abacus width	Height adjust *
6"	2 1/4"	6 1/8"	8 1/16"	-1 7/8"	2 5/8"	7 3/4"	6 1/4"	-1 1/2"	7"	8"	+3 3/8"
8"	3"	8 1/4"	10 1/2"	-1 3/4"	3"	10 1/4"	9"	-1 3/4"	8"	12"	+3 3/4"
10"	3 5/8"	11"	13 3/8"	-2 1/4"	3 7/8"	14 1/2"	12 1/2"	-2"	11 1/8"	15 1/4"	+6"
12"	4 1/2"	12 1/2"	16 1/2"	-1"	4 7/8"	16 3/4"	14"	-5/8"	13 3/4"	17"	+9"
14"	5 1/2"	17 1/2"	23"	-2 1/2"	5 1/2"	19"	16 3/4"	-2 1/2"	14"	21 1/4"	+7"
16"	6 1/8"	17 1/2"	22"	-2"	6 1/4"	22 1/4"	18 1/2"	-1 7/8"	16"	23"	+8 7/8"
18"	6 1/2"	20"	24 1/4"	-2 3/4"	7"	23 1/2"	23"	-2 1/4"	18 1/8"	26 3/4"	+9 7/8"
20"	8 3/4"	25"	31 3/4"	-1 3/8"	8 3/4"	26"	21 1/2"	-1 3/8"	21 3/8"	28 3/8"	+12 5/8"
24"	9"	25 1/4"	33"	-4 7/8"	10 1/4"	34 1/4"	29 1/2"	-3 5/8"	26"	30 7/8"	+13 3/4"
30"	12 1/2"	32"	40 1/2"	TBD	12 3/4"	39"	33"	TBD	30"	39"	n/a

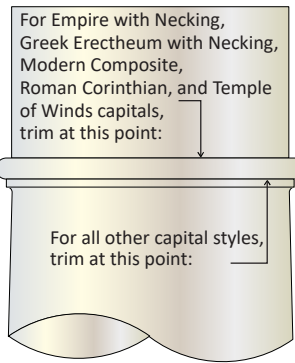

* "Height adjust" column is the adjustment to overall height when using this capital on a column trimmed for architecturally correct installation.

Highlighted sizes are not load bearing and will require a plug. Height shown does not include plug.

ORNAMENTAL CAPS FOR SQUARE NON-TAPERED FRP COLUMNS

Square Capitals install on top of the column and are set on the fillet or the neckring. All of these capitals are structural and will meet the columns' stated load capacities when properly installed. Square Ornamental Capitals are not available in DuraStone™.



Empire



Empire with Necking



Greek Angular Ionic



Greek Erectheum



Greek Erectheum with Necking



Modern Composite



Roman Corinthian



Roman Doric Ornamental



Roman Ionic



Scamozzi



Temple of Winds

Shaft nominal bottom diameter	Empire				Empire with Necking				Greek Angular Ionic				Greek Erectheum				Greek Erectheum with Necking			
	Capital height	Abacus width	Scroll width	Height adjust	Capital height	Abacus width	Scroll width	Height adjust	Capital height	Abacus width	Scroll width	Height adjust	Capital height	Abacus width	Scroll width	Height adjust	Capital height	Abacus width	Scroll width	Height adjust
6"	n/a				7 3/4"	10"	9"	+4 1/8"	n/a				3 3/4"	7 3/4"	11 3/4"	-1/8"	5 3/4"	7 3/4"	11 3/4"	+2 1/8"
8"	5 1/4"	13 1/2"	12 1/4"	+1/8"	10"	13 1/2"	12 1/4"	+5 1/2"	5 1/8"	14 1/4"	13 3/4"	0"	5 1/4"	10 1/2"	15"	+1/8"	7 1/2"	10 1/2"	15"	+3"
10"	6 1/4"	18"	17"	+3/8"	11"	18"	17"	+5 15/16"	6"	17 1/4"	17"	+1/8"	6 1/4"	14 1/2"	21"	+3/8"	9 1/2"	14 1/2"	21"	+4 7/16"
12"	7 1/4"	20 1/4"	19 1/2"	+1"	14 1/4"	20 1/2"	19 1/2"	+9 3/4"	7 1/4"	20 3/4"	19 1/4"	+1"	7"	15"	21"	+2 1/2"	11 1/4"	15"	21"	+6 3/4"
14"	8 3/4"	23"	19 1/2"	+1 1/16"	17"	23"	19 1/2"	+10"	8 3/8"	20 1/2"	19 1/2"	+5/16"	9"	17 1/2"	26"	+15/16"	13 1/2"	17 1/2"	26"	+6 1/2"

Shaft nominal bottom diameter	Modern Composite			Roman Corinthian			Roman Doric Ornamental			Roman Ionic				Scamozzi				Temple of Winds		
	Capital height	Abacus width	Height adjust	Capital height	Abacus width	Height adjust	Capital height	Abacus width	Height adjust	Capital height	Abacus width	Scroll width	Height adjust	Capital height	Abacus width	Scroll width	Height adjust	Capital height	Abacus width	Height adjust
6"	8 1/2"	10 3/4"	+4 7/8"	8 1/2"	12"	+4 7/8"	4 1/2"	10 1/2"	+5/8"	3"	8 1/4"	10 1/2"	-7/8"	3"	10 1/4"	9"	-7/8"	7 1/2"	10 1/2"	+3 7/8"
8"	11 1/2"	16 1/2"	+7"	11 1/2"	15"	+7"	6"	14 1/4"	+7/8"	3 5/8"	10 1/2"	13 1/2"	-1 1/2"	3 7/8"	14 1/2"	12 1/2"	-1 1/4"	10"	13 7/8"	+5 1/2"
10"	14 1/2"	19"	+9 7/16"	14 1/2"	18 1/2"	+9 7/16"	n/a			4 1/2"	12 1/2"	16 1/2"	-1 3/8"	4 7/8"	16 3/4"	14"	-1"	11 5/8"	16 7/8"	+6 1/16"
12"	17"	20"	+12 1/2"	17"	22"	+12 1/2"	9"	21"	+2 3/4"	5 1/2"	17 1/2"	23"	-3/4"	5 1/2"	19"	19 3/4"	-3/4"	14"	21 1/4"	+9 1/2"
14"	22 1/2"	25"	+15 1/2"	20"	27"	+13"	10 1/2"	24"	+2 1/16"	n/a				6 1/4"	22 1/4"	18 1/2"	-1 13/16"	16"	23"	+9"

Height Adjust is based on trimming the shaft at the architecturally correct location.



POLY-CLASSIC®

DST *DuraStone™ Columns*

TEXTURED PAINTABLE COLUMN

- PAINT ANY COLOR
- WEATHER RESISTANT
- READY TO INSTALL
- SAME LOAD CAPACITIES AS FRP COLUMNS
- LIMITED LIFETIME WARRANTY
- LOW MAINTENANCE



FLAME GUARD PROTECTED

Poly-Classic® DuraStone™ Textured Paintable Columns are to achieve the distinction of passing an industry test (ASTME, 84-01) that measures the flame spread and smoke development of building components in a fire.



POLY-CLASSIC® DURASTONE™ COLUMNS

Get the strength and durability of our popular Poly-Classic® FRP columns in a textured finish. Durastone™ columns are available in all the same sizes as our paint grade FRP columns with Tuscan caps and bases. (Roman Doric caps are not available). For specifications and other information please refer to the Poly-Classic® FRP column specifications on pages 13-19.

READY TO INSTALL

Simply cut to length and install. Poly-Classic® DuraStone™ Columns have the same load-bearing capacity as our standard Poly-Classic® FRP Columns. We also have a limited selection of decorative capitals to match the columns. The bases on the larger columns (18" and over) will come in two pieces; when installed the assembly seam will be visible.

Tapered Round DuraStone™ Shafts Available Heights and Load Capacities														Concentric Load *	Eccentric Load *
Column Bottom Diameter ‡	5'	6'	8'	9'	10'	12'	14'	16'	18'	20'	22'	24'			
6"	√	√	√											6,000 lb.	6,000 lb.
8"	√	√	√●	√●	√●									10,000 lb.	6,600 lb.
10"	√	√	√●	√●	√●	√●								14,000 lb.	10,720 lb.
12"	√	√	√●	√●	√●	√●	√	√●						18,000 lb.	13,200 lb.
14"			√	√	√	√	√	√	√	√				20,000 lb.	11,520 lb.
16"	√	√	√	√	√	√	√	√	√	√				20,000 lb.	13,200 lb.
18"			√	√	√	√	√	√	√	√	√	√		20,000 lb.	9,040 lb.
20"		√	√		√	√	√	√	√	√				20,000 lb.	18,960 lb.
24"			√		√	√	√	√	√	√	√	√		20,000 lb.	13,200 lb.

Non-Tapered Round DuraStone™ Shafts Available Heights and Load Capacities								
Column Bottom Diameter ‡	8'	10'	11'	12'	14'	15'	Concentric Load *	Eccentric Load *
8"	√	√					10,000 lb.	8,240 lb.
10"	√	√					14,000 lb.	11,520 lb.
12"	√	√		√			18,000 lb.	11,520 lb.
14"	√	√		√	√		20,000 lb.	18,120 lb.
16"	√	√					20,000 lb.	13,200 lb.
18"	√	√	√				20,000 lb.	9,040 lb.
20"	√	√	√				20,000 lb.	18,960 lb.
24"	√	√		√	√	√	20,000 lb.	13,200 lb.

Non-Tapered Square DuraStone™ Shafts Available Heights and Load Capacities								
Column Bottom Width	8'	9'	10'	12'	14'	16'	Concentric Load *	Eccentric Load *
6"	√		√				6,000 lb.	6,000 lb.
8"	√●△◇	√●△◇	√●△◇				10,000 lb.	10,000 lb.
10"	√◇	√◇	√◇	√			12,800 lb.	12,800 lb.
12"	√	√	√	√	√	√	18,000 lb.	17,320 lb.
14"	√	√	√	√	√	√	20,000 lb.	17,320 lb.

‡ Actual shaft width may be smaller than nominal size shown.

* Load capacities are reduced when loads are not centered. Full documentation regarding eccentric load capacities can be found online at Turncraft.com/pdf/EccentricLoad.pdf and Turncraft.com/pdf/LoadAddendum.pdf.

Please refer to the online documentation regarding maximum eccentricity (beam offset from center) and other specifications.

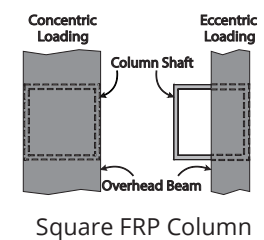
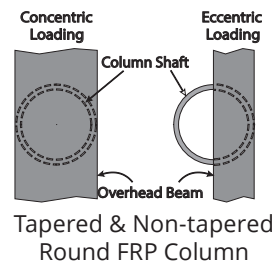

All Poly-Classic® DuraStone™ Columns are available with custom fluting.

- √ Available unfluted.
- Available with standard flutes.
- △ Available raised panel.
- ◇ Available with recessed panel.



POLY-CLASSIC®

DGL *DuraGlass™ Columns*

- EASY TO CUT AND INSTALL
- DECAY RESISTANT
- LOW MAINTENANCE
- LIGHTWEIGHT COLUMNS
- NOW AVAILABLE IN 30" ROUND
- IMPACT RESISTANT
- LIMITED LIFETIME WARRANTY
- READY TO PRIME AND PAINT

LIGHTWEIGHT FIBERGLASS COLUMNS EASILY HANDLE THE LOAD

Sometimes the most beautiful solutions are the most simple. Poly-Classic® DuraGlass™ square columns from Turncraft offer the classic beauty that homeowners and commercial property owners appreciate. Made from lightweight fiberglass, these columns are easy to cut, easy to install, and strong enough to carry heavy loads. Like other Poly-Classic® columns, DuraGlass™ columns are decay resistant and require little maintenance.

PLAN TYPES

Poly-Classic® Duraglass™ Columns are available in the following plan types. Please specify when you order. (Fractional components shown are typical. Customer may specify actual returns, wall thicknesses, etc.)

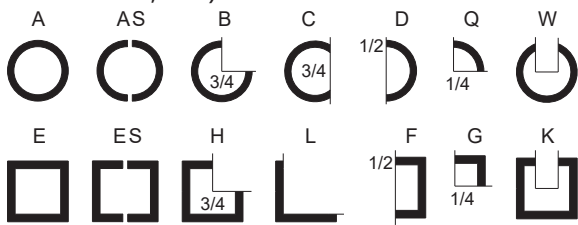

TimeSaver cap and base made exclusively for our 8" DuraGlass™ square column.
Our TimeSaver cap and base offers the easiest and quickest installation in the industry.

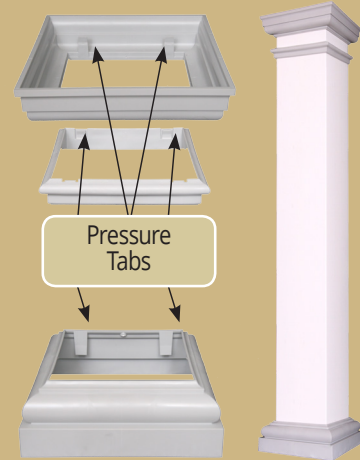

Customers claim: "The TimeSaver cap and base has cut our installation time in half."



DuraGlass™
Tuscan
Non-tapered
Square

DuraGlass™
Tuscan
Non-Tapered
Square with Neck

DuraGlass™
Bungalow
Tapered
Square

DuraGlass™
Tuscan
Tapered
30" Round

DuraGlass™
Tuscan
Non-Tapered
30" Round

DURAGLASS™ NON-TAPERED SQUARE COLUMNS

Column nominal width †	Shaft height (A)	Shaft bottom †		Shaft top		Space available inside shaft		Load capacity
		Outside width (B)	Inside width (C)	Shaft neck ‡	Astragal ring (D)	For round support	For square support	
8"	6'	7 5/8"	7 1/8"	4 1/2"	3/4"	6 3/4"	6 3/4"	5,000lb.
	8'							
	9'							
	10'							
	12'							
10"	6'	9 5/8"	9 1/8"	5"	3/4"	8 3/4"	8 3/4"	6,000lb.
	8'							
	9'							
	10'							
	12'							
12"	6'	11 5/8"	11 1/8"	5 1/2"	3/4"	10 3/4"	10 3/4"	7,000lb.
	8'							
	9'							
	10'							
	12'							
16"	8'	15 7/8"	15 1/8"	7 5/8"	1"	14 3/4"	14 3/4"	20,000lb.
	10'							
	12'							
	14'							
	16'							
	18'							
	20'							

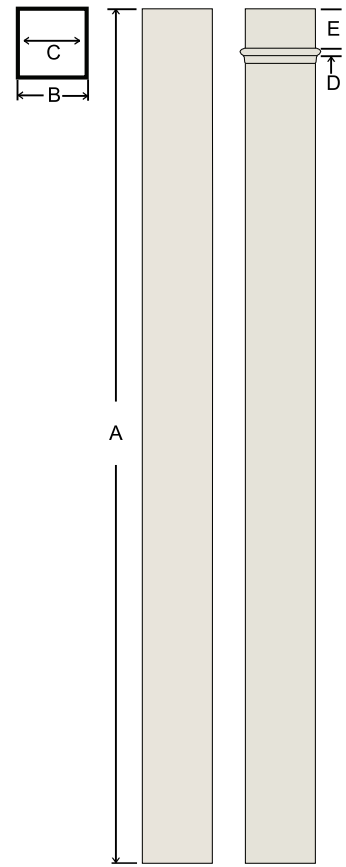

† Actual shaft net widths may vary from nominal size shown.

‡ Necking is shipped loose for pultruded columns. Spacing shown is typical, but may be adjusted by the installer. (Necking on 16" columns is integrated with the shaft.)

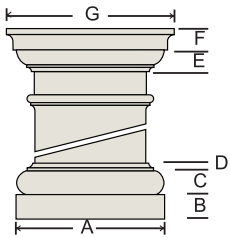

Tuscan Cap and Base

Column width	Tuscan Base					Tuscan Cap				Material
	Plinth		Torus		Total height	Echinus	Abacus		Total height	
	(A)	(B)	(C)	(D)	(B-D)	(E)	(F)	(G)	(E-F)	
8"	10 9/16"	1 3/4"	1 5/8"	1/2"	3 7/8"	1 5/16"	1 3/8"	10 11/16"	2 11/16"	ABS
10"	12 19/16"	1 3/4"	1 5/8"	1/2"	3 7/8"	1 5/16"	1 3/8"	12 11/16"	2 11/16"	Pultruded FG
12"	17"	2 3/4"	2 3/8"	7/8"	6"	1 7/8"	2"	17 1/4"	3 7/8"	Polyurethane
16"	22 1/4"	3 7/8"	3 3/8"	1 1/8"	8 3/8"	2 13/16"	2 3/4"	22 1/2"	5 9/16"	Fiberglass

DURAGLASS™ TAPERED BUNGALOW COLUMNS

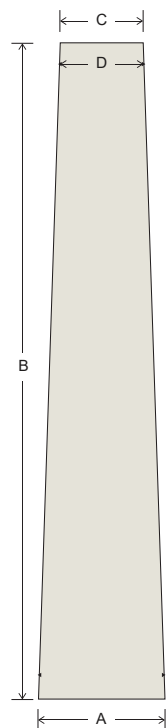

Shaft nominal bottom width *	Shaft Specifications			
	Shaft bottom width NET	Shaft bottom inside width	Shaft top width NET	Shaft top inside width
	(A)	(B)	(C)	(D)
10"	9 5/8"	9"	5 5/8"	5"
12"	11 5/8"	11"	7 5/8"	7"
16"	15 5/8"	15"	11 5/8"	11"

* Actual width is 3/8 less than nominal

Shaft nominal bottom width	PVC Base				PVC Cap			
	Plinth width	Plinth height	Profile height	Total height	Abacus width	Abacus height	Profile height	Total height
	A	B	C	B-C	D	E	F	E-F
10"	13 5/8"	1"	1 1/4"	2 1/4"	9 5/8"	1"	1 1/8"	2 1/8"
12"	15 5/8"	1"	1 1/4"	2 1/4"	11 5/8"	1"	1 1/8"	2 1/8"
16"	19 5/8"	1"	1 1/4"	2 1/4"	15 5/8"	1"	1 1/8"	2 1/8"

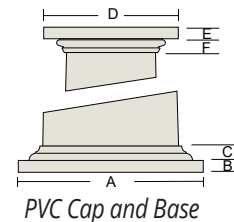

PVC Cap and Base

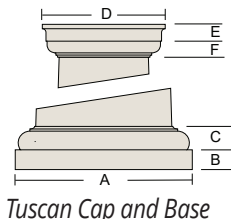

Tuscan Cap and Base

Shaft nominal bottom width	Tuscan Base				Tuscan Cap			
	Plinth width	Plinth height	Profile height	Total height	Abacus width	Abacus height	Profile height	Total height
	A	B	C	B-C	D	E	F	E-F
10"	13 1/8"	1 11/16"	2"	3 11/16"	8 1/2"	1 7/16"	1 3/8"	2 13/16"
12"	15 1/8"	1 11/16"	2"	3 11/16"	10 1/2"	1 7/16"	1 3/8"	2 13/16"
16"	19 1/8"	1 11/16"	2"	3 11/16"	14 1/2"	1 7/16"	1 3/8"	2 13/16"

DURAGLASS™ ROUND TAPERED COLUMNS

Standard DuraGlass™ column shafts are the same height as the listed size. Tuscan cap and base and Attic base go around the shaft, and do not affect the overall height. Ornamental capitals are set on top of the column astragal, and will affect the overall height: see the Poly-Classic® Ornamental Capitals specifications (page 18) for available capital sizes and more information.

Column nominal diameter *	Shaft height (A)	Shaft neck		Shaft bottom *		Shaft top *		Space available inside shaft		Load capacity
		Neck height (B)	Astragal ring (C)	Outside diameter (D)	Inside diameter (E)	Outside diameter (F)	Inside diameter (G)	For round support	For square support	
30"	8'	13 5/8"	2 1/2"	30"	29"	24 1/2"	23 1/2"	23"	16 1/4"	25,000 lb.
	10'									
	12'									
	14'									
	16'									
	18'									
	20'									
	22'									
	24'									
	26'									
	28'									
30'										

* Actual shaft net diameters may be smaller than nominal size shown.

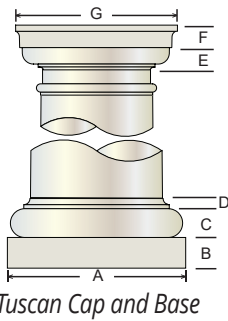
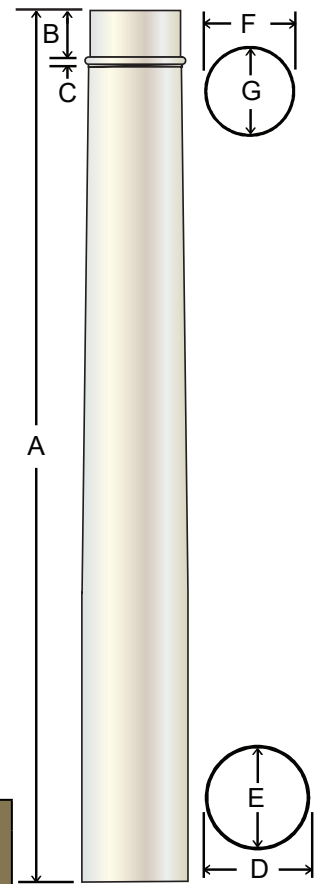

Column diameter	Tuscan Base				Tuscan Cap				Material	
	Plinth		Torus		Total height	Echinus		Abacus		Total height
	(A)	(B)	(C)	(D)	(B-D)	(E)	(F)	(G)	(E-F)	
30"	40 1/2"	7 1/4"	6 1/2"	2 3/4"	16 1/2"	4 1/16"	5 1/8"	35 3/4"	9 9/16"	Fiberglass

Column diameter	Optional Attic Base						Material	
	Plinth		Torus			Total height		
	(A)	(B)	(C)	(D)	(E)	(F)	(B-F)	
30"	40 1/2"	7 1/4"	3 7/8"	3 5/8"	2 5/8"	1 7/8"	19 1/4"	Fiberglass

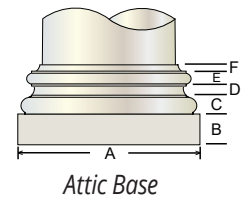

DURAGLASS™ ROUND NON-TAPERED COLUMNS

Standard DuraGlass™ column shafts are the same height as the listed size. Tuscan caps and bases and Attic bases go around the shaft, and do not affect the overall height. Tuscan bases are used (upside-down) as caps. Ornamental capitals are not available for non-tapered shafts.

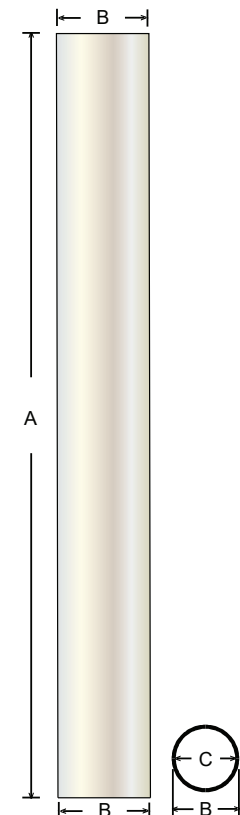

Column nominal diameter *	Shaft height (A)	Shaft bottom *		Shaft top *		Space available inside shaft		Load capacity
		Outside diameter (B)	Inside diameter (C)	Outside diameter (B)	Inside diameter (C)	For round support	For square support	
30"	8'	30"	29"	30"	29"	28 1/2"	20 1/8"	25,000 lb.
	10'							
	12'							
	14'							
	15'							

* Actual shaft net diameters may be smaller than nominal size shown.

Column diameter	Tuscan Base				Tuscan Cap				Material		
	Plinth		Torus		Total height	Echinus		Abacus		Total height	
	(A)	(B)	(C)	(D)	(B-D)	(D)	(C)	(B)	(A)	(B-D)	
30"	40 1/2"	7 1/4"	6 1/2"	2 3/4"	16 1/2"	2 3/4"	6 1/2"	7 1/4"	40 1/2"	16 1/2"	Fiberglass

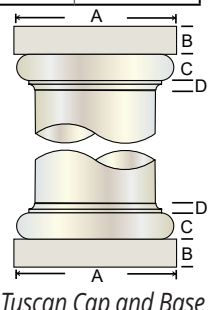



POLY-CLASSIC®

PCP

Porch Posts

- READY TO INSTALL
- LOW MAINTENANCE
- PROTECTIVE UV INHIBITOR
- RAIL ATTACHMENT INSERT
- SQUARE STEEL CORE
- SEAMLESS WINDOW GRADE VINYL
- READY TO PRIME AND PAINT
- LIMITED LIFETIME WARRANTY

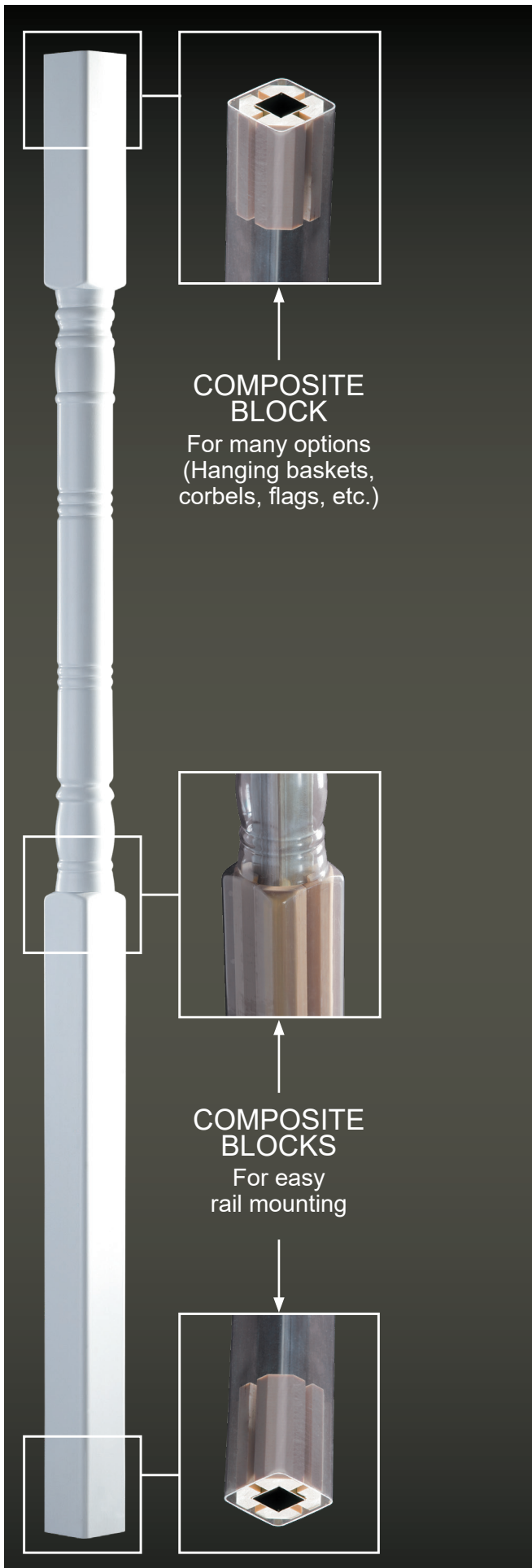

POLY-CLASSIC® PORCH POSTS

Excellent design, performance, and low maintenance are built into every Turncraft Poly-Classic® porch post. For easy rail attachment and substantial load-bearing strength, each Poly-Classic® porch post has a galvanized steel square core and sturdy inserts at critical connection points. Constructed from seamless window grade vinyl with UV inhibitor, Poly-Classic® porch posts are delivered with a matte white finish but can be painted to match your project. They will deliver eye-catching beauty for many years to come without the maintenance of traditional products. Installation hardware is included with the post.

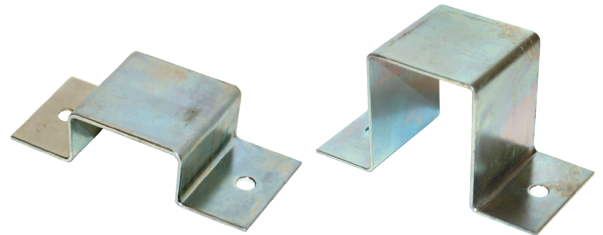

Includes two standard brackets.

Larger brackets for uplift (1500 lb.) sold separately.

POLY POSTS

Nominal width	Actual width	height	Base height	weight	Load bearing capacity
5"	4 1/8"	96"	42 1/8"	23	3,000 lb.
5"	4 1/8"	108"	42 1/8"	27	2,500 lb.

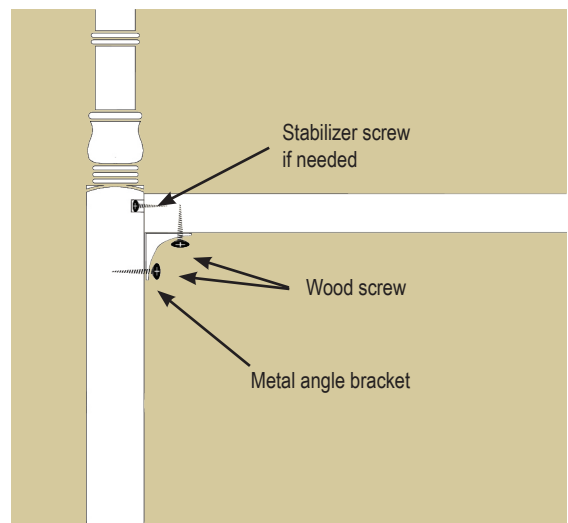



POLY-CLASSIC®

CRF

Craftsman Series

- MADE FROM EXPANDED CELLULAR PVC
- E-Z LOCK JOINT DESIGN
- ASSEMBLES AROUND A STRUCTURAL SUPPORT
- MIX-N-MATCH
- LOW MAINTENANCE
- LIMITED LIFETIME WARRANTY
- READY TO PRIME AND PAINT
- CUSTOM SIZES AVAILABLE

**THE STYLE IS TIMELESS.
NOW THE COLUMN IS, TOO.**

Born out of the understated, practical tradition of the early 1900s Arts and Crafts movement, the square tapered column has become popular in modern adaptations of the the Craftsman, Prairie, Bungalow, Country and Mission style homes of today. Now this timeless style is available in expanded cellular PVC for quick, easy assembly and virtually maintenance-free performance!

PRECISION MITER JOINTS

Vertical edges of Craftsman shafts (tapered, non-tapered, pedestal and newel post styles) all incorporate the E-Z Lock miter joint for consistently straight miters.

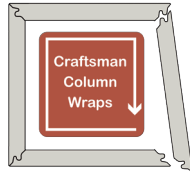

PLAN TYPES

Craftsman Series are available in the following plan types. Please specify when you order. (Customer may specify actual returns, wall thicknesses, etc.) Plan O & N are available only as non-tapered.



PANEL STYLES

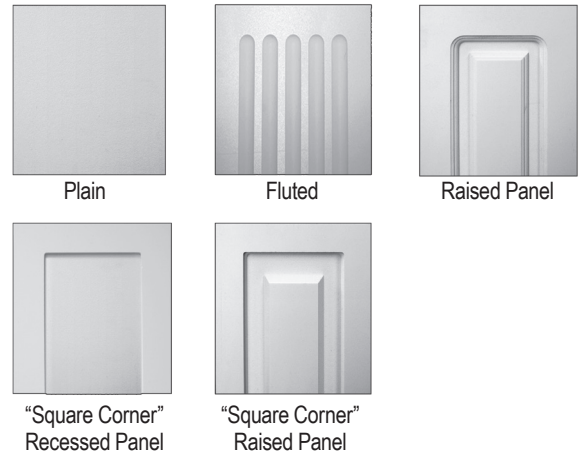

CRAFTSMAN PEDESTALS AND NEWELS



POLY-CLASSIC® CRAFTSMAN TAPERED SQUARE

Craftsman columns are available plain, or with three different paneled options: raised panel, “square corner” raised panel, and recessed panel. (Since all tooling used for routing the panels is done with round bits, there will always be some radius in the corners. The “square corner” style uses the smallest bit possible to minimize that radius - about 1/8”.)

Nominal width	Available heights (A)	Shaft dimensions				Panel dimensions †			
		Bottom		Top		From bottom of shaft ‡	From top of shaft	From side of shaft	Width of routed channel
		Outside width (B)	Inside width (C)	Outside width (E)	Inside width (D)				
10"	4'	9 5/8"	8 3/8"	5 5/8"	4 3/8"	10 1/2"	2 1/2"	1 1/4"	3/4"
	5'								
	6'								
	8'								
12"	4'	11 5/8"	10 3/8"	7 5/8"	6 3/8"	10 1/2"	2 1/2"	1 1/2"	1 1/4"
	5'								
	6'								
	8'								
16"	4'	15 5/8"	14 3/8"	11 5/8"	10 3/8"	10 1/2"	2 1/2"	1 1/2"	1 1/4"
	5'								
	6'								
	8'								
20"	4'	19 5/8"	18 3/8"	13 5/8"	12 3/8"	10 1/2"	2 1/2"	1 1/2"	1 1/4"
	5'								
	6'								
	8'								
24"	4'	23 5/8"	22 3/8"	15 5/8"	14 3/8"	10 1/2"	2 1/2"	1 1/2"	1 1/4"
	5'								
	6'								
	8'								

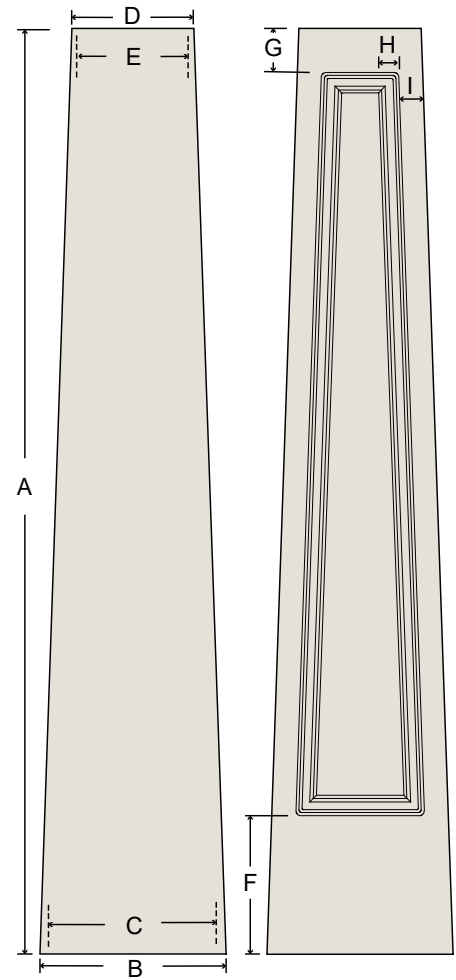

† Dimensions (except width) also apply to recessed panel shafts.

‡ Dimension shown is for standard shafts. On custom height columns the panels start 5 1/4" from the bottom.

* Actual shaft height is 1/2" less than shown.

Custom sizes may be requested, up to 24' in height, and up to 48" width.

POLY-CLASSIC® CRAFTSMAN TAPERED CAP AND BASE STYLES

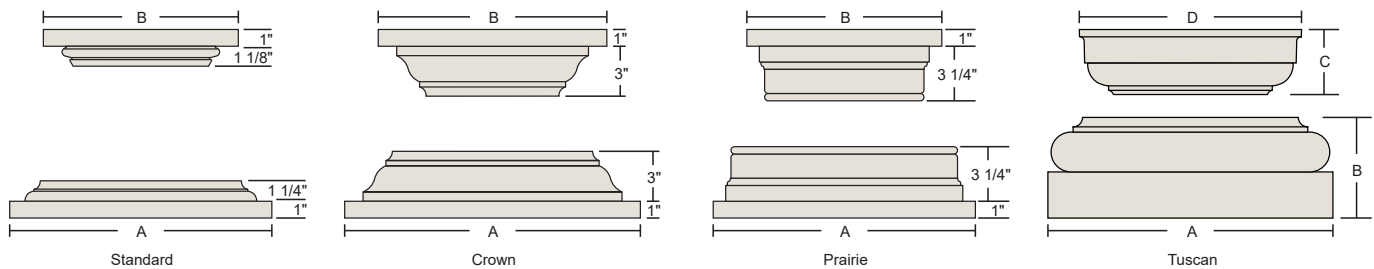

Column nominal bottom width	Standard		Crown		Prairie		Tuscan *	
	Base	Cap	Base	Cap	Base	Cap	Base	Cap **
	(A)	(B)	(A)	(B)	(A)	(B)	(A)	(B)
10"	13 5/8"	9 5/8"	15 5/8"	11 5/8"	13 5/8"	9 5/8"	13 1/2"	9 1/2"
12"	15 5/8"	11 5/8"	17 5/8"	13 5/8"	15 5/8"	11 5/8"	17"	13"
16"	19 5/8"	15 5/8"	21 5/8"	17 5/8"	19 5/8"	15 5/8"	20 5/8"	17 3/4"
20"	23 5/8"	17 5/8"	25 5/8"	19 5/8"	23 5/8"	17 5/8"	24 5/8"	20 1/4"
24"	27 5/8"	19 5/8"	29 5/8"	21 5/8"	27 5/8"	19 5/8"	28 5/8"	22 3/8"

* Tuscan cap/base have no platform—they wrap around the shaft. For inside widths, see the specifications for shaft inside widths.

** Tuscan cap widths may vary depending on height of shaft. The pitch (side angles) change and may require adjustment of cap width.

Note: The total height of the parts (shown in the charts) do NOT add to the overall height of the column. The bottom and top plates do add 1" each (2" total) to the shaft height, allowing extra flexibility in installation.

POLY-CLASSIC® CRAFTSMAN NON-TAPERED SQUARE

Nominal width	Shaft dimensions		Panel and flute spacing †		Panels †		Flutes	
	Net bottom width	Inside bottom width	From bottom of shaft ‡	From top of shaft	From side of shaft	Width of routed channel	Number of flutes	Flute width
	(B)	(C)	(D)	(E)	(G)	(F)		
6"	5 5/8"	4 3/8"	16 3/4"	8 1/2"	1 1/4"	3/4"	20	1/2"
8"	7 5/8"	6 3/8"	16 3/4"	8 1/2"	1 1/2"	1 1/4"	20	3/4"
10"	9 5/8"	8 3/8"	16 3/4"	8 1/2"	1 1/2"	1 1/4"	20	1"
12"	11 5/8"	10 3/8"	16 3/4"	8 1/2"	1 1/2"	1 1/4"	20	1 1/4"
14"	13 5/8"	12 3/8"	16 3/4"	9"	2"	1 1/4"	24	1 1/4"
16"	15 5/8"	14 3/8"	16 3/4"	9 1/4"	2 1/4"	1 1/4"	28	1 1/4"
18"	17 5/8"	16 3/8"	16 3/4"	9 1/2"	2 1/2"	1 1/4"	32	1 1/4"
20"	19 5/8"	18 3/8"	16 3/4"	9 3/4"	2 3/4"	1 1/4"	36	1 1/4"
22"	21 5/8"	20 3/8"	16 3/4"	10"	3"	1 1/4"	40	1 1/4"
24"	23 5/8"	22 3/8"	16 3/4"	10 1/4"	3 1/4"	1 1/4"	44	1 1/4"

† Dimensions except width also apply to recessed panel shafts.

‡ Dimension shown is for standard shafts. On custom height columns the panels/flutes start 4" from the top of the base selected, and dimension (G) from the cap (or optional neck moulding).

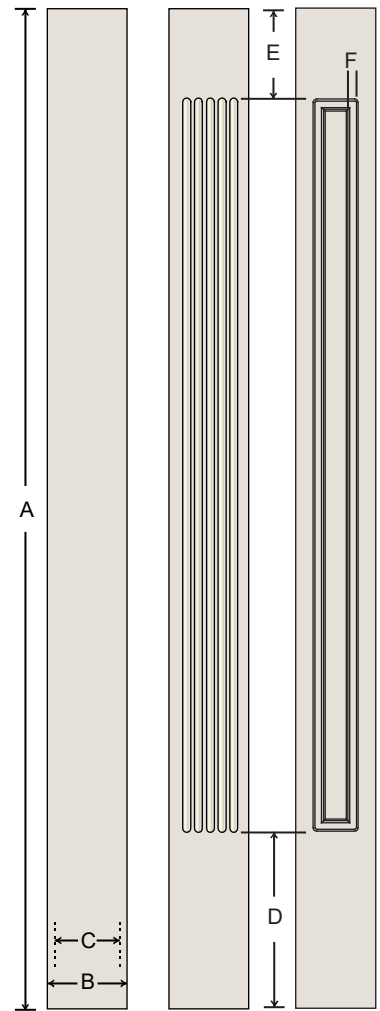

Nominal column width	Standard sizes (A)					Nominal column width	Standard sizes (A)								
	4'	5'	6'	8'	10'		8'	10'	12'	14'	16'	18'	20'	22'	24'
6"	√	√	√	√	√	14"	√	√	√	√					
8"	√	√	√	√	√	16"	√	√	√	√	√				
10"	√	√	√	√	√	18"	√	√	√	√	√	√			
12"	√	√	√	√	√	20"	√	√	√	√	√	√	√		
						22"	√	√	√	√	√	√	√	√	
						24"	√	√	√	√	√	√	√	√	√

Custom widths and heights may be requested in any size up to 24' tall and 48" wide.

Cap and base trim and platforms will be adjusted as needed for the revised shaft width.

POLY-CLASSIC® CRAFTSMAN NON-TAPERED CAP AND BASE STYLES

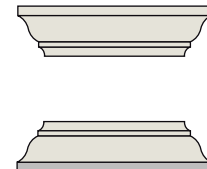
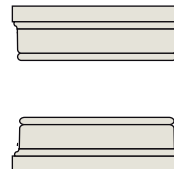
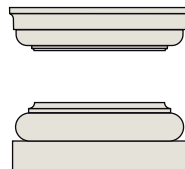
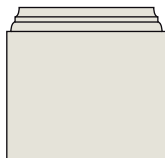
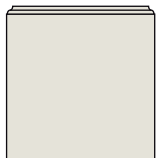
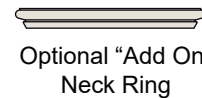

Standard

Mission

Tuscan

Prairie

Crown

Column nominal width	Standard cap & base width (A)	Mission cap & base width (A)	Tuscan cap & base				Prairie cap & base width (A)	Crown cap & base width (A)
			Base		Cap			
			Width (A)	Height (B)	Width (C)	Height (D)		
6"	6 7/8"	7 5/8"	8"	3 7/32"	8 7/16"	2 1/32"	8 1/8"	9 5/8"
8"	8 7/8"	9 5/8"	11 3/8"	4 1/4"	11 1/4"	2 11/16"	10 1/8"	11 5/8"
10"	10 7/8"	11 5/8"	13 1/2"	5 1/4"	13 7/32"	3 9/16"	12 1/8"	13 3/8"
12"	12 7/8"	13 5/8"	17"	6"	17 1/4"	3 7/8"	14 1/8"	15 5/8"
14"	14 7/8"	15 5/8"	18 5/8"	7 1/2"	19"	5"	16 1/8"	17 5/8"
16"	16 7/8"	17 5/8"	20 5/8"	7 1/2"	21"	5"	18 1/8"	19 5/8"
18"	18 7/8"	19 5/8"	22 5/8"	7 1/2"	23"	5"	20 1/8"	21 5/8"
20"	20 7/8"	21 5/8"	24 5/8"	7 1/2"	25"	5"	22 1/8"	23 5/8"
22"	22 7/8"	23 5/8"	26 5/8"	7 1/2"	27"	5"	24 1/8"	25 5/8"
24"	24 7/8"	25 5/8"	28 5/8"	7 1/2"	29"	5"	26 1/8"	27 5/8"

POLY-CLASSIC® CRAFTSMAN PEDESTALS AND NEWELS



Standard Pedestal



Prairie Pedestal
Recessed Panel



Prairie Pedestal
Raised Panel

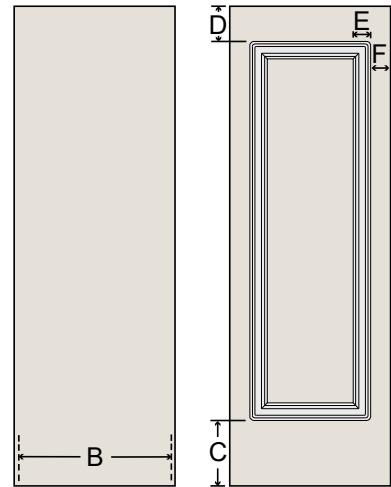

Nominal width	Shaft widths		Panels (Standard trim)		Panels (Prairie trim)		Panels		Available heights						
	Outside (B)	Inside (C)	From bottom of shaft (D)	From top of shaft (E)	From bottom of shaft (D)	From top of shaft (E)	Width of router channel (F)	From side of shaft (G)	32"	36"	40"	44"	48"	54"	60"
									√	√	√	√	√	√	√
6"	5 5/8"	4 3/8"	4 3/4"	3 3/4"	4 3/4"	2 5/8"	3/4"	1 1/4"	√	√	√	√	√	√	√
8"	7 5/8"	6 3/8"	4 3/4"	3 3/4"	4 3/4"	2 5/8"	1 1/4"	1 1/2"	√	√	√	√	√	√	√
10"	9 5/8"	8 3/8"	4 3/4"	3 3/4"	4 3/4"	2 5/8"	1 1/4"	1 1/2"	√	√	√	√	√	√	√
12"	11 5/8"	10 3/8"	4 3/4"	3 3/4"	4 3/4"	2 5/8"	1 1/4"	1 1/2"	√	√	√	√	√	√	√
14"	13 5/8"	12 3/8"	5 1/4"	4 1/4"	5 1/4"	3 1/8"	1 1/4"	2"	√	√	√	√	√	√	√
16"	15 5/8"	14 3/8"	5 1/2"	4 1/2"	5 1/2"	3 3/8"	1 1/4"	2 1/4"	√	√	√	√	√	√	√
18"	17 5/8"	16 3/8"	5 3/4"	4 3/4"	5 3/4"	3 5/8"	1 1/4"	2 1/2"	√	√	√	√	√	√	√
20"	19 5/8"	18 3/8"	6"	5"	6"	3 7/8"	1 1/4"	2 3/4"	√	√	√	√	√	√	√
22"	21 5/8"	20 3/8"	6 1/4"	5 1/4"	6 1/4"	4 1/8"	1 1/4"	3"	√	√	√	√	√	√	√
24"	23 5/8"	22 3/8"	6 1/2"	5 1/2"	6 1/2"	4 3/8"	1 1/4"	3 1/4"	√	√	√	√	√	√	√
26"	25 5/8"	24 3/8"	6 3/4"	5 3/4"	6 3/4"	4 5/8"	1 1/4"	3 1/2"	√	√	√	√	√	√	√
28"	27 5/8"	26 3/8"	7"	6"	7"	4 7/8"	1 1/4"	3 3/4"	√	√	√	√	√	√	√
30"	29 5/8"	28 3/8"	7 1/4"	6 1/4"	7 1/4"	5 1/8"	1 1/4"	4"	√	√	√	√	√	√	√

* Typically, pedestals are 4" wider than the column it is supporting, or about the same width as the base of the column which it supports.

POLY-CLASSIC® CRAFTSMAN PEDESTALS AND NEWEL CAPS AND BASES

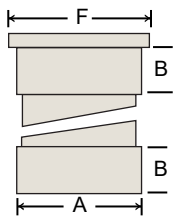

Standard Trim

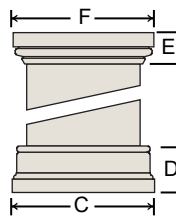

Prairie Trim

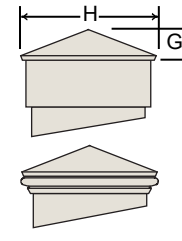

Pyramid Cap

Column nominal width	Standard Trim		Prairie Trim				Pyramid Cap	
	Width	Height	Base width	Base height	Top height	Top width †	Cap height ± 1/16"	Cap width
	(A)	(B)	(C)	(D)	(E)	(F)	(G)	(H)
6"	6 7/8"	3 1/4"	8 1/8"	3 1/4"	2 1/8"	7 5/8"	2 1/16"	7 7/8"
8"	8 7/8"	3 1/4"	10 1/8"	3 1/4"	2 1/8"	9 5/8"	2 1/2"	9 7/8"
10"	10 7/8"	3 1/4"	12 1/8"	3 1/4"	2 1/8"	11 5/8"	2 7/8"	11 7/8"
12"	12 7/8"	3 1/4"	14 1/8"	3 1/4"	2 1/8"	13 5/8"	3 1/4"	13 7/8"
14"	14 7/8"	3 1/4"	16 1/8"	3 1/4"	2 1/8"	15 5/8"	3 5/8"	15 7/8"
16"	16 7/8"	3 1/4"	18 1/8"	3 1/4"	2 1/8"	17 5/8"	4"	17 7/8"
18"	18 7/8"	3 1/4"	20 1/8"	3 1/4"	2 1/8"	19 5/8"	4 3/8"	19 7/8"
20"	20 7/8"	3 1/4"	22 1/8"	3 1/4"	2 1/8"	21 5/8"	4 13/16"	21 7/8"
22"	22 7/8"	3 1/4"	24 1/8"	3 1/4"	2 1/8"	23 5/8"	5 3/16"	23 7/8"
24"	24 7/8"	3 1/4"	26 1/8"	3 1/4"	2 1/8"	25 5/8"	5 9/16"	25 7/8"
26"	26 7/8"	3 1/4"	28 1/8"	3 1/4"	2 1/8"	27 5/8"	6 5/16"	27 7/8"
28"	28 7/8"	3 1/4"	30 1/8"	3 1/4"	2 1/8"	29 5/8"	6 3/8"	29 7/8"
30"	30 7/8"	3 1/4"	32 1/8"	3 1/4"	2 1/8"	31 5/8"	6 3/4"	31 7/8"

POLY-CLASSIC® CRAFTSMAN ORNAMENTAL CAPITALS

Designed with crisp, true architectural detail, Ornamental Capitals artfully capture natural themes and images. Capitals for square Non-tapered Poly-Classic® Craftsman columns are crafted from poly/resin, and will ship split in half (to reassemble around the load support). Each style is proportionally scaled for the width of the shaft. The Empire with Necking, Greek

Erectheum with Necking, Modern Composite, Roman Corinthian, Roman Doric Ornamental, and Temple of Winds capitals will fit more accurately when the optional neck moulding is included. Since the shafts will be manufactured to be correct with the selected capital, there is no need to worry about a height adjustment value with PVC columns. Larger sizes may be available.



Empire



Empire with Necking



Greek Angular Ionic



Greek Erectheum



Greek Erectheum with Necking



Modern Composite



Roman Corinthian



Roman Doric Ornamental



Roman Ionic



Scamozzi



Temple of Winds

Shaft nominal bottom diameter	Empire			Empire with necking			Greek Angular Ionic			Greek Erectheum			Greek Erectheum with necking			Modern Composite		
	Capital height	Abacus width	Scroll width	Capital height	Abacus width	Scroll width	Capital height	Abacus width	Scroll width	Capital height	Abacus width	Scroll width	Capital height	Abacus width	Scroll width	Capital height	Abacus width	Scroll width
6"	3 3/4"	10"	9"	7 3/4"	10"	9"	n/a			3 3/4"	7 3/4"	11 3/4"	5 3/4"	7 3/4"	11 3/4"	8 1/2"	10 3/4"	n/a
8"	5 1/4"	13 1/2"	22 1/4"	10"	13 1/2"	12 1/4"	5 1/8"	14 1/4"	13 3/4"	5 1/4"	10 1/2"	15"	7 1/2"	10 1/2"	15"	11 1/2"	16 1/2"	n/a
10"	6 1/4"	18"	17"	11"	18"	17"	6"	17 1/4"	17"	6 1/4"	14 1/2"	21"	9 1/2"	14 1/2"	21"	14 1/2"	19"	n/a
12"	7 1/4"	20 1/4"	19 1/2"	14 1/2"	20 1/2"	19 1/2"	7 1/4"	20 3/4"	19 1/4"	6 3/4"	15"	20 1/2"	11 1/4"	15"	21"	17"	20"	n/a
14"	8 3/4"	23"	19 1/2"	17"	23"	19 1/2"	8 3/8"	20 1/2"	19 1/2"	9"	17 1/2"	26"	13 1/2"	17 1/2"	26"	n/a		
16"	10"	32"	26 1/4"	n/a			9 3/4"	24 1/4"	19 3/4"	10"	22 1/2"	29"	15"	22 1/2"	29"	22 1/2"	25"	n/a
18"	11 1/4"	34"	28"	n/a			n/a			11"	26"	36"	17"	26"	36"	n/a		
20"	12 3/4"	35 1/2"	35"	19"	35 1/2"	35"	12 3/4"	35"	34 1/2"	13"	30 1/2"	43"	19"	30 1/2"	43"	n/a		

Shaft nominal bottom diameter	Roman Corinthian			Roman Doric Ornamental			Roman Ionic			Scamozzi			Temple of Winds		
	Capital height	Abacus width	Scroll width	Capital height	Abacus width	Scroll width	Capital height	Abacus width	Scroll width	Capital height	Abacus width	Scroll width	Capital height	Abacus width	Scroll width
6"	8 1/2"	12"	n/a	4 1/2"	10 1/2"	n/a	3"	8 1/4"	10 1/2"	2 7/8"	10"	8"	7 1/2"	10 1/2"	n/a
8"	12"	15"	n/a	6"	14 1/4"	n/a	3 5/8"	10 1/2"	13 1/2"	3 1/2"	11"	9 3/8"	10"	13 7/8"	n/a
10"	14 1/2"	18 1/2"	n/a	7"	16 1/4"	n/a	4 1/2"	12 1/2"	16 1/2"	4 7/8"	16 3/4"	14"	11 5/8"	16 7/8"	n/a
12"	17"	22"	n/a	9"	21"	n/a	5 1/2"	17 1/2"	23"	5 1/2"	19"	16 3/4"	16"	19"	n/a
14"	20"	27"	n/a	10 1/2"	24"	n/a	n/a			6 1/4"	22 1/4"	18 1/2"	16"	23"	n/a
16"	23"	33 1/2"	n/a	12 1/2"	28"	n/a	6 1/2"	20"	24 1/4"	7 1/2"	25"	20 1/4"	18 1/8"	26 3/4"	n/a
18"	25 1/2"	39"	n/a	n/a			8 3/4"	25"	31 3/4"	8 3/4"	26"	21 1/2"	21 1/2"	28"	n/a
20"	28 1/2"	42"	n/a	n/a			9"	25 1/4"	33"	10 1/4"	34 1/4"	29 1/2"	23 1/4"	34 1/2"	n/a

MIX-N-MATCH

CRAFTSMAN SERIES COLUMNS WITH CRAFTSMAN SERIES PEDESTALS

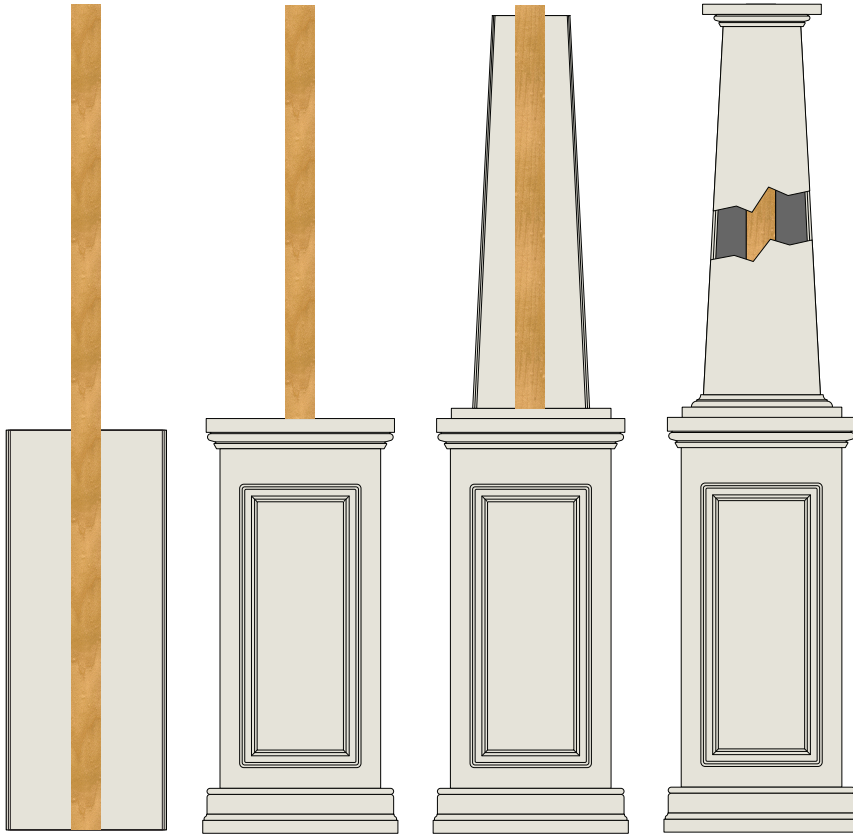

Columns are installed around an existing load-bearing support (pressure treated post, steel pole, etc).

1. Assemble three sides of the pedestal and slide in place around the structure.
2. Install final piece of pedestal around structure.
3. Install pedestal trim and top plate on pedestal.
4. Assemble 3 sides of column and place on pedestal around structure.
5. Install final piece of column around structure.
6. Install column cap and base around column and secure to beam and to pedestal.

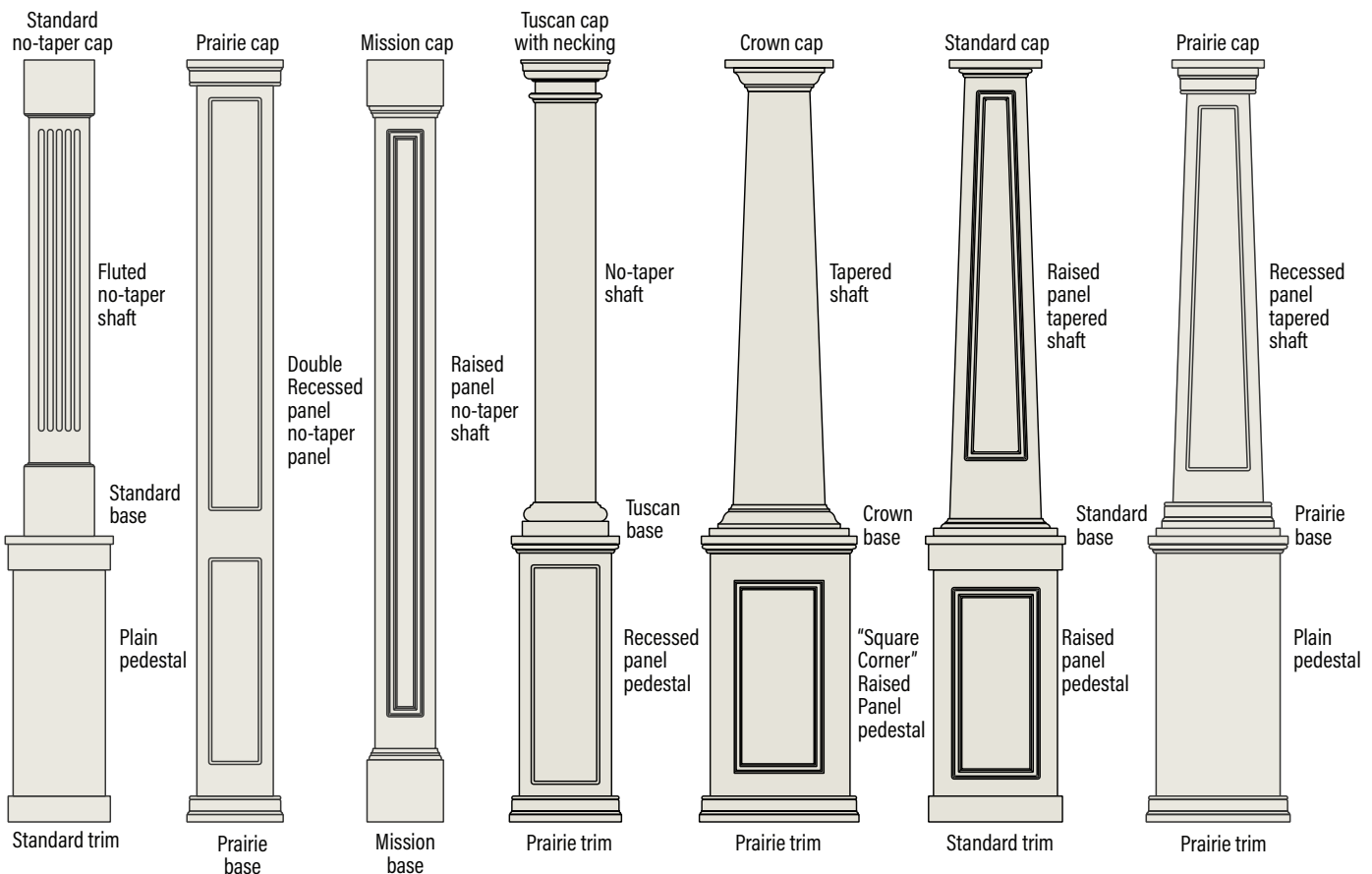

MIX-N-MATCH

CRAFTSMAN SERIES PEDESTALS WITH POLY-CLASSIC® FRP COLUMNS

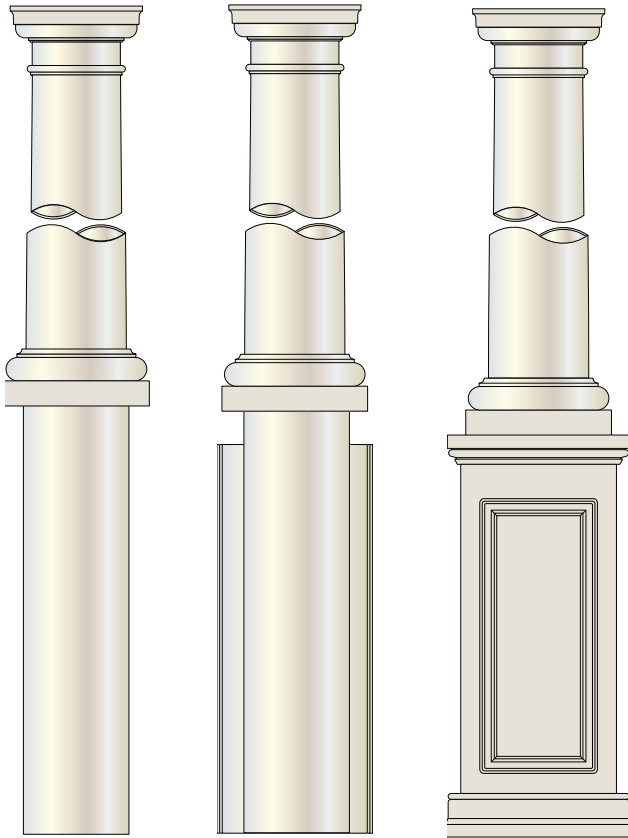

No load support is required, since the FRP column is load bearing (unless split).

The column should be installed following our normal installation instructions, with the exception that the base is not attached: the base should temporarily be held above the height of the pedestal.

The Craftsman pedestal is then assembled around the FRP column, and the pedestal trim installed following the typical pedestal installation instructions.

Following the pedestal assembly, the column base is lowered to the top of the pedestal and attached.

Pedestals can also be installed around existing columns to update and freshen the look.

Please specify if your column is round or square, as well as the width, so that we can correctly cut out the top platform of the pedestal to install around your column.

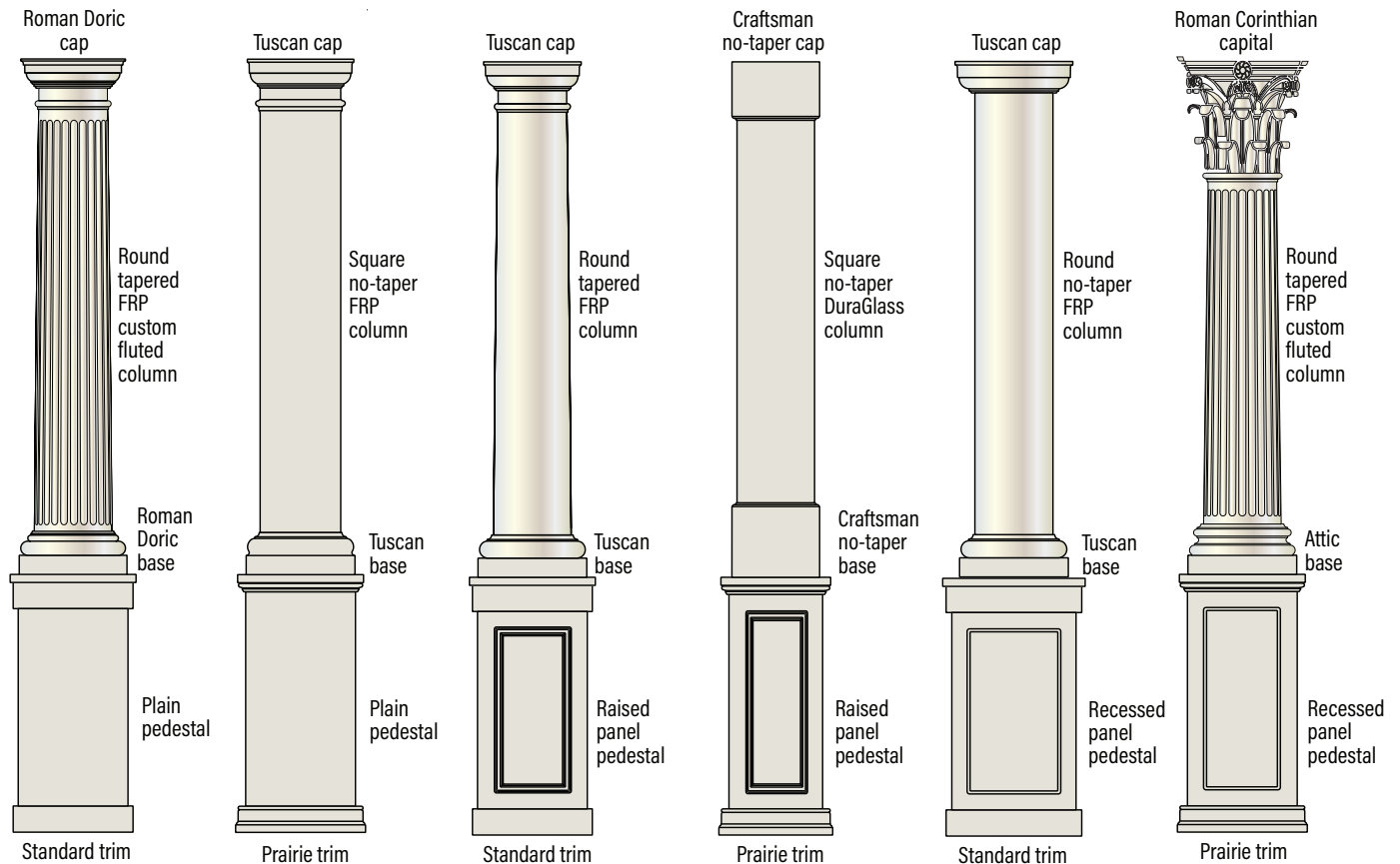



TURNCRAFT

ARC

Architectural Series

- ARCHITECTURALLY CORRECT DETAILS
- ALL ORDERS OF CLASSICAL COLUMNS
- CORRECT PROPORTIONS OR CUSTOM DESIGNS
- INTERIOR AND EXTERIOR
- WIDEST RANGE OF STYLES AND SIZES
- ANY WOOD SPECIES
- FACTORY OPTIONS INCLUDE PRIMING AND ASPHALT COATING
- CEDAR COLUMNS HAVE A 10 YEAR LIMITED WARRANTY

Comparison of the Orders

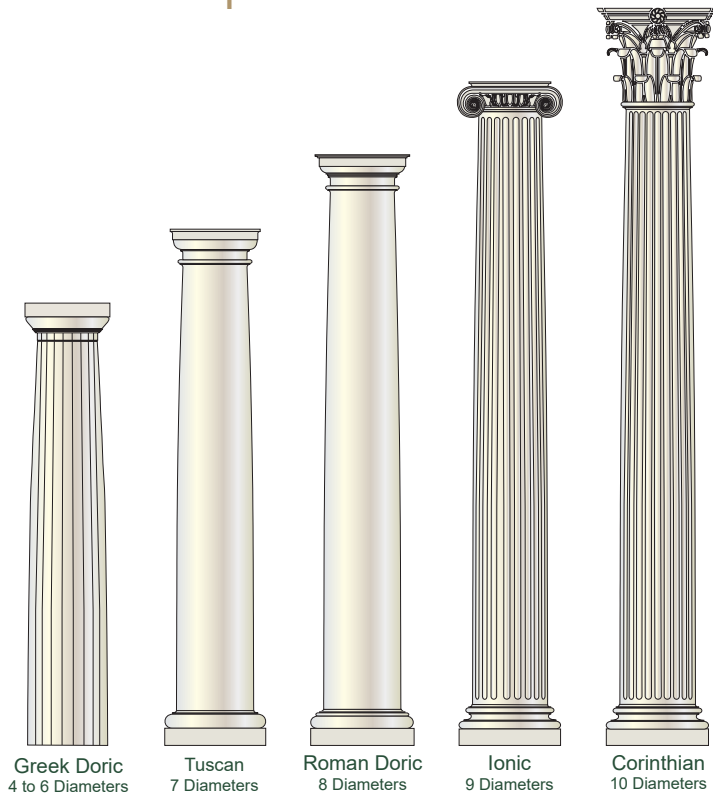

Turncraft Architectural wood columns are our premier product for precise attention to detail both in design and quality. Unlike FRP columns, where the manufacturing processes dictate some alterations to details, our wood columns are closest to true architectural specifications such as proportion, fluting and entasis (taper or bow).

Architectural columns are best proportioned when following the suggestions of William Ware (*The American Vignola*), Robert Chitham (*The Classic Orders of Architecture*), Palladio and others to emulate the ancient architecture of Greece and Rome. The illustration "Comparison of the Orders" shows how the height and diameter ratio affects columns of a similar diameter. Tip: to determine the correct diameter for a column in the height you need, simply divide the height by the diameter factor given below the style chosen. For example, at a two-story height of 198", an Ionic column (9 diameters) should be 22" in diameter ($198/9=22$), or a Tuscan column (7 diameters) should be 28" in

diameter.

In addition to the round columns shown, Turncraft Architectural can provide wood columns in non-architectural proportions, in many plan types, including squares, octagons and pilasters, either straight or tapered, as well as coupled columns, and other custom configurations.

Using our computerized lathes, our wood columns typically have the correct column entasis (taper or bow) – the lower one-third of the shaft is straight, and the upper two-thirds has a diminishing taper. The "Entasis Taper" illustration shows precisely how this is generated. We also have the ability to customize the shaft taper. For example, straight tapers are common, as well as barrel columns where the center of the shaft is larger than both ends.

For exterior use, the recommended wood for shafts is cedar because of its inherent resistance to insects and wood rot, and carries a ten year limited warranty. Pine is also available, with a one year limited warranty. Cap and base for exterior columns are usually polyurethane (up to 16" columns) or fiberglass (18" and larger).

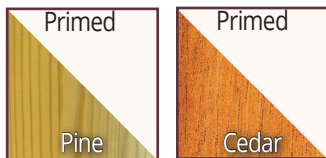

For interior use, Turncraft is able to manufacture columns from a wide variety of woods. Paint grade woods are typically finger-jointed pine or poplar, and stain grade can be practically any species imaginable.



Our most popular stain grade species are red oak, mahogany, cherry, maple, alder, and walnut. The examples here show the differences in grain and color. However it's best to keep in mind that the finish used affects the final color, so this isn't an exact match.

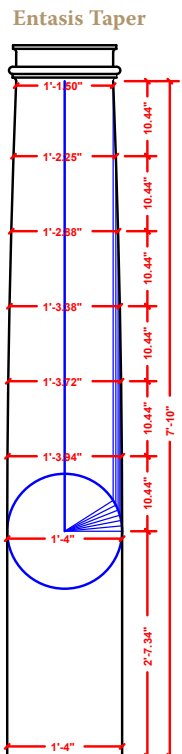

GREEK DORIC SPECIFICATIONS

Available in fluted or unfluted versions. They may be ordered in Vignola's architectural proportions or in custom combinations of column lengths and widths as well as in non-tapered cylinders. Square architectural columns and pilasters to match detail of round tapered columns are available.

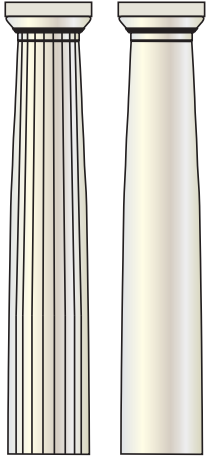
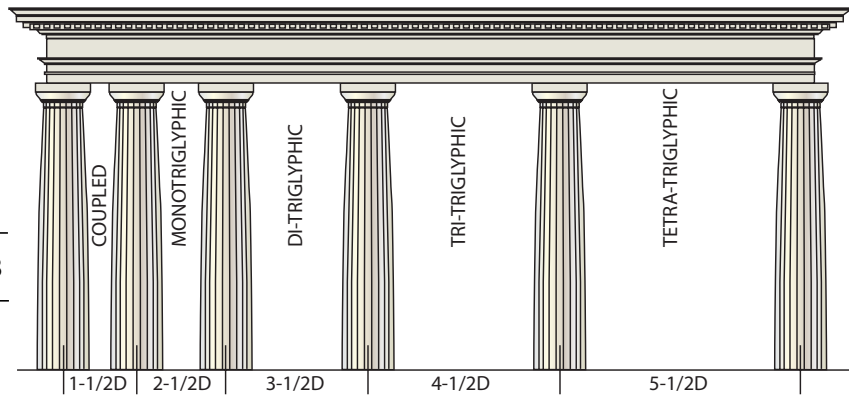
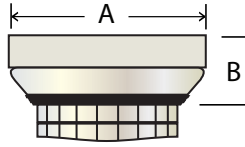

Shaft nominal bottom diameter	Shaft Specifications						Cap Specifications		
	Bottom		Top		Flutes		Specifications		Materials
	Net O.D.	Net I.D.	Net O.D.	Net I.D.	Number	Width	Abacus width (A)	Cap height (B)	
6"	6"	2 1/4"	5"	2"	20	1 5/16"	7 3/8"	2 1/16"	W
8"	8"	4 1/4"	6 1/2"	3 1/2"	20	1 1/4"	9 1/4"	3 5/16"	W
10"	10"	6 3/8"	8 1/4"	5 1/4"	20	1 9/16"	11 5/8"	3 15/16"	W
12"	12"	7 7/8"	9 3/4"	6 3/4"	20	1 7/8"	13 3/4"	4 7/8"	W
14"	14"	10 1/8"	11 1/4"	8 1/4"	20	2 3/16"	16"	5 1/2"	W
16"	16"	11 1/16"	12 3/4"	9 3/4"	20	2 1/2"	18 1/8"	6"	W
18"	18"	12"	14 1/2"	11 1/2"	20	2 13/16"	20 1/2"	6 3/4"	W
20"	20"	14 1/4"	16"	13"	20	3 1/8"	22 5/8"	7 3/8"	W
22"	22"	16 1/4"	18"	15"	20	3 7/16"	25 1/4"	8 1/4"	W
24"	24"	18 1/4"	19 1/2"	16 1/2"	20	3 3/4"	27 1/4"	8 7/8"	W

TUSCAN SPECIFICATIONS

Available in fluted or unfluted versions. They may be ordered in Vignola's architectural proportions or in custom combinations of column lengths and widths as well as in non-tapered cylinders. Square architectural columns and pilasters to match detail of round tapered columns are available.

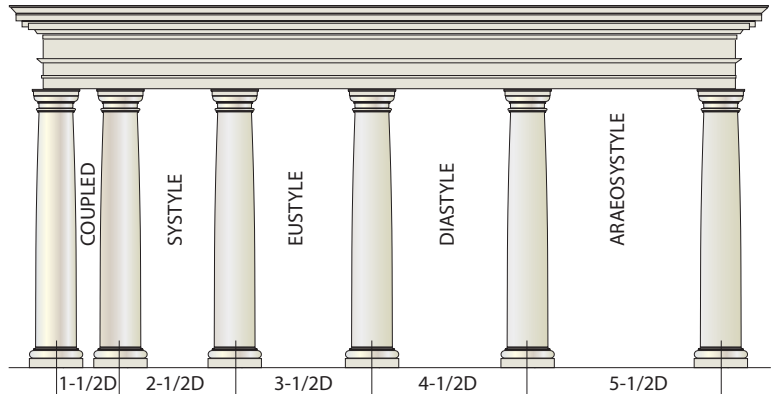
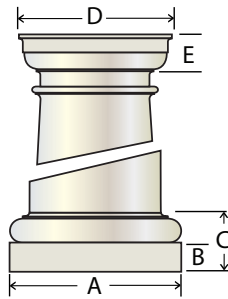

Shaft Nominal Bottom Diameter	Shaft Specifications						Tuscan Cap and Base Specifications					Materials
	Bottom		Top		Flutes		Base			Cap		
	Net O.D.	Net I.D.	Net O.D.	Net I.D.	Number	Width	Plinth width (A)	Plinth height (B)	Total height (C)	Abacus width (D)	Total height (E)	
4"	4"	0	3 1/4"	0	18	7/16"	5 3/8"	1"	2 5/16"	5 1/8"	1 3/16"	W P
6"	6"	3"	4 3/4"	2 1/2"	24	1/2"	8"	1 1/2"	3 1/4"	7 1/2"	1 3/4"	W P
8"	8"	5 1/4"	6 1/2"	4 3/8"	24	11/16"	10 3/4"	1 7/8"	4 1/4"	9 3/8"	2 3/8"	W P
10"	10"	7 1/4"	8 1/2"	6 3/8"	24	7/8"	13 3/8"	2 3/8"	5 1/4"	12 1/8"	3"	W P
12"	12"	9"	10"	7 3/4"	24	1"	16 1/8"	2 3/4"	6"	14 3/8"	3 3/8"	W P
14"	14"	10 1/8"	12"	9"	24	1 1/4"	18 3/4"	3 3/8"	7 3/8"	17 1/8"	4"	W P F
15"	15"	11 1/16"	12 3/4"	10"	24	1 11/32"	20 1/8"	3 5/8"	7 7/8"	18 3/16"	4 5/16"	W P
16"	16"	12"	13 1/2"	10"	24	1 1/16"	21 1/2"	3 7/8"	8 3/8"	19 1/4"	4 5/8"	W P F
18"	18"	14 1/4"	15"	12"	24	1 1/2"	24 1/4"	4 1/4"	9 5/8"	21 1/2"	5 1/8"	W F
20"	20"	16 1/4"	17"	13"	24	1 11/16"	27"	4 3/4"	10 3/4"	24 1/4"	5 5/8"	W F
22"	22"	18 1/4"	18 1/2"	15"	24	1 15/16"	29 3/4"	5 1/4"	12 1/8"	26 1/2"	6 1/4"	W F
24"	24"	20 1/4"	20"	17"	24	2 1/8"	32 1/2"	5 3/4"	13 1/4"	28 3/4"	6 7/8"	W F
26"	26"	22 1/8"	22"	19"	24	2 1/4"	35"	6 1/4"	14 1/2"	31 1/2"	7 3/8"	W F
28"	28"	24 1/8"	23 1/2"	21"	24	2 11/16"	38"	6 3/4"	15 1/2"	33 3/8"	8"	W F
30"	30"	26 1/4"	25"	22"	24	2 7/8"	40 1/2"	7 1/4"	16 1/2"	35 3/4"	8 5/8"	W F
32"	32"	27"	27"	23"	24	3"	42 3/4"	7 3/4"	17 3/4"	37 3/8"	9 1/4"	F
34"	34"	29"	28 1/2"	24 1/2"	24	3 1/4"	45 1/2"	8 1/2"	19 3/8"	41"	9 5/8"	F
36"	36"	31"	30"	26"	24	3 1/4"	48"	9"	20 3/8"	42 3/4"	10 1/2"	F

ROMAN DORIC SPECIFICATIONS

Available in fluted or unfluted versions. They may be ordered in Vignola's architectural proportions or in custom combinations of column lengths and widths as well as in non-tapered cylinders. Square architectural columns and pilasters to match detail of round tapered columns are available

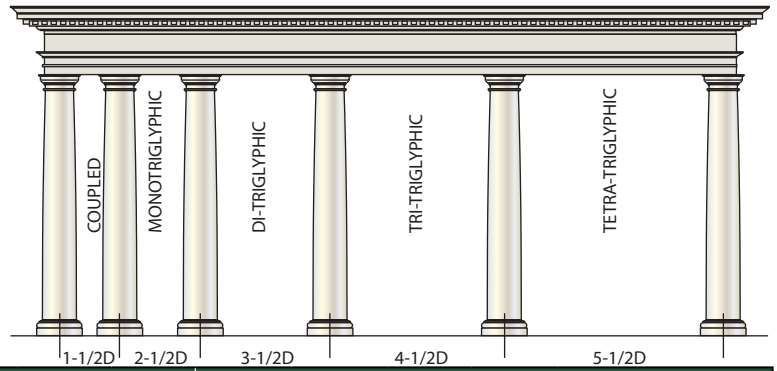
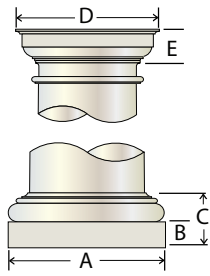

Shaft nominal bottom diameter	Shaft Specifications						Roman Doric Cap and Base Specifications					Materials Wood, Fiberglass, Polyurethane
	Bottom		Top		Flutes		Base			Cap		
	Net O.D.	Net I.D.	Net O.D.	Net I.D.	Number	Width	Plinth width (A)	Plinth height (B)	Total height (C)	Abacus width (D)	Total height (E)	
4"	4"	0	3 1/4"	0	18	7/16"	5 3/8"	1"	2 1/8"	5 1/8"	1 1/2"	W P
6"	6"	3"	4 3/4"	2 1/2"	24	1/2"	8"	1"	3 1/4"	7 1/2"	2"	W P
8"	8"	5 1/4"	6 1/2"	4 3/8"	24	11/16"	10 3/4"	1 7/8"	4 1/4"	9 3/4"	2 5/8"	W P
10"	10"	7 1/4"	8 1/2"	6 3/8"	24	7/8"	13 3/8"	2 3/8"	5 3/8"	12 1/2"	3 1/8"	W P
12"	12"	9"	10"	7 3/4"	24	1"	16 1/8"	2 3/4"	6 3/16"	14 3/4"	4"	W P
14"	14"	10 1/8"	12"	9"	24	1 1/4"	18 3/4"	3 3/8"	7 3/8"	17 1/2"	4 11/16"	W P F
15"	15"	11 1/16"	12 3/4"	10"	24	1 11/32"	20 1/8"	3 5/8"	8 1/16"	18 11/16"	5 1/32"	W P
16"	16"	12"	13 1/2"	10"	24	1 7/16"	21 1/2"	3 7/8"	8 3/4"	19 7/8"	5 3/8"	W P F
18"	18"	14 1/4"	15"	12"	24	1 1/2"	24 1/4"	4 1/4"	9 7/8"	22 1/4"	6"	W F
20"	20"	16 1/4"	17"	13"	24	1 11/16"	27"	4 3/4"	11"	25"	6 3/4"	W F
22"	22"	18 1/4"	18 1/2"	15"	24	1 15/16"	29 3/4"	5 1/4"	12"	27 3/8"	7 3/8"	W F
24"	24"	20 1/4"	20"	17"	24	2 1/8"	32 1/2"	5 3/4"	13 1/4"	29 3/4"	7 15/16"	W F
26"	26"	22 1/8"	22"	19"	24	2 1/4"	35"	6 1/4"	14 3/8"	32 1/2"	8 11/16"	W F
28"	28"	24 1/8"	23 1/2"	21"	24	2 11/16"	38"	6 3/4"	15 3/8"	34 5/8"	9 3/8"	W F
30"	30"	26 1/4"	25"	22"	24	2 7/8"	40 1/2"	7 1/4"	16 5/8"	37"	9 15/16"	W F
32"	32"	27"	27"	23"	24	3"	42 3/4"	7 3/4"	17 3/4"	39 1/4"	10 9/16"	F
34"	34"	29"	28 1/2"	24 1/2"	24	3 1/4"	45 1/2"	8 1/2"	19 1/4"	42 1/8"	11 5/16"	F
36"	36"	31"	30"	26"	24	3 1/4"	48"	9"	20 1/4"	44 1/8"	12"	F

ROMAN IONIC SPECIFICATIONS

Available in fluted or unfluted versions. They may be ordered in Vignola's architectural proportions or in custom combinations of column lengths and widths as well as in non-tapered cylinders.

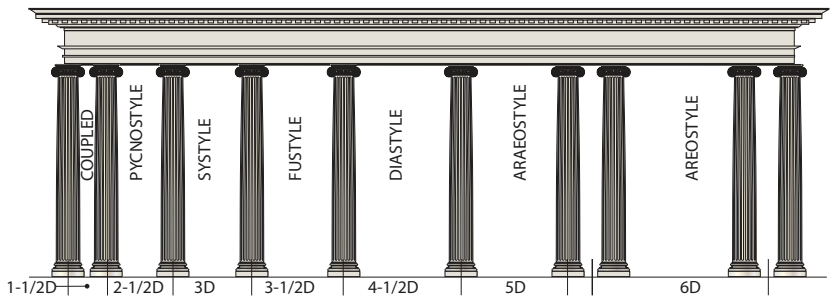
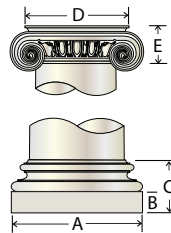

Shaft Nominal Bottom Diameter	Shaft Specifications						Base			Cap			Materials Wood, ** Composite, Poly/Resin
	Bottom		Top		Flutes		Attic Base Specifications			Materials Wood, Fiberglass, Polyurethane	Roman Ionic Specifications*		
	Net O.D.	Net I.D.	Net O.D.	Net I.D.	Number	Width	Plinth Width (A)	Plinth Height (B)	Total height (C)		Abacus Width (D)	Capital Height (E)	
6"	6"	3"	4 3/4"	2 1/2"	24	1/2"	8"	1"	3 1/2"	W P	6 1/8"	2 1/4"	W C P
8"	8"	5 1/4"	6 1/2"	4 3/8"	24	11/16"	10 3/4"	1 7/8"	5 1/8"	W P	8 1/4"	3"	W C P
10"	10"	7 1/4"	8 1/2"	6 3/8"	24	7/8"	13 3/8"	2 3/8"	6 1/4"	W P	11"	3 5/8"	W C P
12"	12"	9"	10"	7 3/4"	24	1"	16 1/8"	2 3/4"	7 1/4"	W P	12 1/2"	4 1/2"	W C P
14"	14"	10 1/8"	12"	9"	24	1 1/4"	18 3/4"	3 3/8"	8 3/4"	W P F	17 1/2"	5 1/2"	C P
15"	15"	11 1/16"	12 3/4"	10"	24	1 11/32"	20 1/8"	3 5/8"	9 1/16"	W P	17 1/2"	5 1/2"	C P
16"	16"	12"	13 1/2"	10"	24	1 7/16"	21 1/2"	3 7/8"	10 1/8"	W P F	17 1/2"	6 1/8"	C P
18"	18"	14 1/4"	15"	12"	24	1 1/2"	24 1/4"	4 1/4"	11 3/8"	W F	20"	6 1/2"	C P
20"	20"	16 1/4"	17"	13"	24	1 11/16"	27"	4 3/4"	12 7/8"	W F	20"	6 1/2"	C P
22"	22"	18 1/4"	18 1/2"	15"	24	1 15/16"	29 3/4"	5 1/4"	14 1/4"	W F	25"	8 3/4"	C P
24"	24"	20 1/4"	20"	17"	24	2 1/8"	32 1/2"	5 3/4"	15 1/16"	W F	25 1/4"	9"	C
26"	26"	22 1/8"	22"	19"	24	2 1/4"	35"	6 1/4"	16 7/8"	W F	26 1/2"	9 1/2"	C
28"	28"	24 1/8"	23 1/2"	21"	24	2 11/16"	38"	6 3/4"	18 1/8"	W F	32"	12 1/2"	C
30"	30"	26 1/4"	25"	22"	24	2 7/8"	40 1/2"	7 1/4"	19 1/4"	W F	32"	12 1/2"	C

*Sizes shown for Roman Ionic Cap. See Ornamental Capital table for sizes of all available styles.

**Not all capital styles available in wood, not all styles in all sizes.

ROMAN CORINTHIAN SPECIFICATIONS

Corinthian Columns are available in fluted or unfluted versions. They may be ordered in Vignola's architectural proportions or in custom combinations of column lengths and widths as well as in non-tapered cylinders. Square architectural columns and pilasters to match detail of round tapered columns are available.

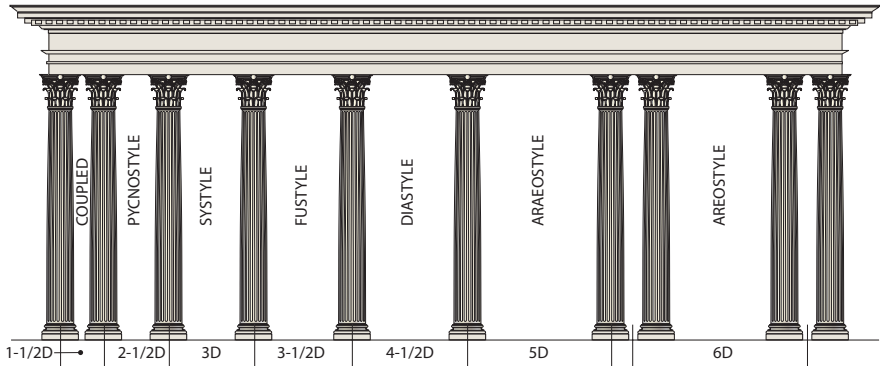
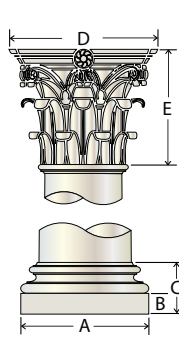

Shaft nominal bottom diameter	Shaft Specifications						Roman Corinthian Base			Roman Corinthian Cap			
	Bottom		Top		Flutes		Attic Base Specifications			Materials	Specifications		Materials
	Net O.D.	Net I.D.	Net O.D.	Net I.D.	Number	Width	Plinth width (A)	Plinth height (B)	Total Height (C)	Wood, Fiberglass, Polyurethane	Abacus width (D)	Total height (E)	Wood, Composite, Poly/Resin
6"	6"	3"	4 3/4"	2 1/2"	24	1/2"	8"	1"	3 1/2"	W P F	9 1/2"	7"	W C P
8"	8"	5 1/4"	6 1/2"	4 3/8"	24	1 1/16"	10 3/4"	1 7/8"	5 1/8"	W P F	12"	8 1/2"	W C P
10"	10"	7 1/4"	8 1/2"	6 3/8"	24	7/8"	13 3/8"	2 3/8"	6 1/4"	W P F	15"	12"	W C P
12"	12"	9"	10"	7 3/4"	24	1"	16 1/8"	2 3/4"	7 1/4"	W P F	18 1/2"	14 1/2"	W C P
14"	14"	10 1/8"	12"	9"	24	1 1/4"	18 3/4"	3 3/8"	8 3/4"	W P F	22"	17"	C P
15"	15"	11 1/16"	12 3/4"	10"	24	1 1/32"	20 1/8"	3 5/8"	9 7/16"	W P F	22"	17"	C P
16"	16"	12"	13 1/2"	10"	24	1 1/16"	21 1/2"	3 7/8"	10 1/8"	W P F	27"	20"	C P
18"	18"	14 1/4"	15"	12"	24	1 1/2"	24 1/4"	4 1/4"	11 3/8"	W F	32 1/2"	23"	C P
20"	20"	16 1/4"	17"	13"	24	1 1/16"	27"	4 3/4"	12 1/8"	W F	39"	25 1/2"	C P
22"	22"	18 1/4"	18 1/2"	15"	24	1 5/16"	29 3/4"	5 1/4"	14 1/4"	W F	42"	28 1/2"	C P
24"	24"	20 1/4"	20"	17"	24	2 1/8"	32 1/2"	5 3/4"	15 1/16"	W F	42"	28 1/2"	C P
26"	26"	22 1/8"	22"	19"	24	2 1/4"	35"	6 1/4"	16 7/8"	W F	42"	32"	C
28"	28"	24 1/8"	23 1/2"	21"	24	2 1/16"	38"	6 3/4"	18 1/8"	W F	46"	34"	C
30"	30"	26 1/4"	25"	22"	24	2 7/8"	40 1/2"	7 1/4"	19 1/4"	W F	46 1/2"	37 1/2"	C

CALCULATED SAFE-LOAD CAPACITIES

Diameter	Pine	Cedar	Available Heights*
6"	2,567 lb.	5,146 lb.	3' to 10'
8"	4,114 lb.	7,646 lb.	4' to 12'
10"	5,497 lb.	10,474 lb.	5' to 16'
12"	6,620 lb.	12,535 lb.	6' to 20'
14"	11,017 lb.	15,282 lb.	6' to 20'
16"	12,307 lb.	17,343 lb.	6' to 24'
18"	14,487 lb.	19,404 lb.	6' to 24'
20"	16,688 lb.	22,151 lb.	6' to 30'
22"	18,426 lb.	24,212 lb.	8' to 30'
24"	20,018 lb.	26,272 lb.	8' to 30'
26"	22,252 lb.	36,870 lb.	8' to 30'
28"	24,001 lb.	39,519 lb.	8' to 30'
30"	25,746 lb.	42,169 lb.	8' to 30'
32"	42,080 lb.	55,317 lb.	8' to 30'
34"	44,567 lb.	57,476 lb.	8' to 30'
36"	47,054 lb.	61,794 lb.	8' to 30'

The sample columns tested supported loads at least four times the calculated values to the left prior to failure. The load was applied concentrically through the axis of the column. Loads shown are valid only if there is uniform contact between the full area of column ends and the cap and base units. Loads are provided for your convenience only and are not exact values. Consult a structural engineer for the most accurate load estimates.

* Custom sizes available on request.

PLAN TYPES

Architectural Columns are available in the following plan types. Please specify when you order. Custom plan types are also available. (Fractional components shown are typical. Customer may specify actual returns, wall thicknesses, etc).

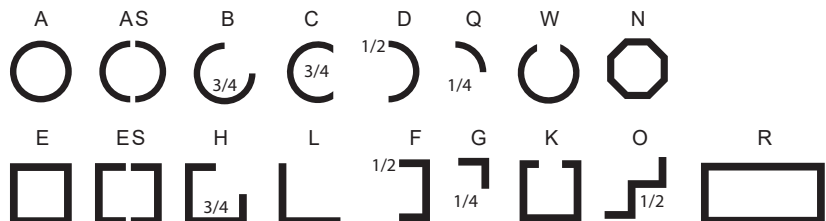



ORNAMENTAL CAPITALS FOR ARCHITECTURAL WOOD COLUMNS

Shaft nominal bottom width	1 Empire			2 Empire with Necking			3 Greek Erectheum			4 Scamozzi			5 Greek Erectheum with Necking		
	Abacus width	Capital height	Scroll width	Abacus width	Capital height	Scroll width	Abacus width	Capital height	Scroll width	Abacus width	Capital height	Scroll width	Abacus width	Capital height	Scroll width
6"	9"	3 1/8"	8 3/4"	9"	6 7/8"	8 3/4"	6 3/4"	3 1/4"	8 1/2"	7 3/4"	2 5/8"	6 1/4"	n/a		
8"	10"	3 3/4"	9"	10"	7 3/4"	9"	7 3/4"	4 1/2"	11 3/4"	10 1/4"	3"	9"	n/a		
10"	16"	5 1/2"	13 1/2"	13 1/2"	10"	12 1/4"	12"	5 1/2"	17 1/2"	16"	4 1/2"	14"	n/a		
12"	18"	6 3/4"	17"	18"	11"	17"	14 1/2"	6 1/4"	21"	17 1/2"	5"	15 1/2"	14 1/2"	9 1/2"	21"
14"	20 1/2"	7 1/4"	19 1/2"	20 1/2"	14 1/2"	19 1/2"	15"	7"	21"	19 1/2"	6"	16 1/2"	15"	11 1/4"	21"
15"	23"	8 3/4"	19 1/2"	20 1/2"	14 1/2"	19 1/2"	n/a			19 1/2"	6"	16 1/2"	15"	11 1/4"	21"
16"	23"	8 3/4"	19 1/2"	23"	17"	19 1/2"	17 1/2"	9"	26"	22 1/4"	6 1/4"	18 1/2"	17 1/2"	13 1/2"	26"
18"	32"	10"	25 1/4"	32"	15"	26 1/4"	22"	10 1/4"	29"	25"	7 1/2"	20 1/4"	22 1/2"	15"	29"
20"	34"	11 1/4"	28"	34"	17 1/4"	28"	26"	11"	36"	28 1/2"	8 1/2"	24"	26"	17"	36"
22"	35 1/2"	12 3/4"	35"	34"	17 1/4"	28"	26"	11 1/4"	36 1/4"	28 1/2"	8 1/2"	24"	26"	17"	36"
24"	35 1/2"	12 3/4"	35"	35 1/2"	19"	35"	30 1/2"	13"	43"	34 1/4"	10 1/4"	29 1/2"	30 1/2"	19"	43"
26"	37"	13"	35"	37"	19"	35"	32 1/2"	13"	43"	35 1/4"	11"	29 3/4"	32 1/2"	19 1/2"	43"
28"	n/a			37"	19"	35"	31"	15"	45 1/2"	39"	12 3/4"	33"	31"	24 3/4"	45 1/2"
30"	n/a			n/a			31"	15"	45 1/2"	39"	12 3/4"	33"	31"	24 3/4"	45 1/2"
36"	n/a			n/a			42 1/2"	19 1/4"	60 1/2"	46"	15"	38 1/2"	n/a		

Shaft nominal bottom width	6 Roman Corinthian		7 Roman Doric Ornamental		8 Modern Composite		9 Roman Ionic			10 Greek Angular Ionic			11 Temple of Winds	
	Abacus width	Capital height	Abacus width	Capital height	Abacus width	Capital height	Abacus width	Capital height	Scroll width	Abacus width	Capital height	Scroll width	Abacus width	Capital height
4"	n/a		n/a		n/a		n/a			n/a			6"	6"
6"	9 1/2"	7"	8 3/4"	4"	8"	7"	6 1/8"	2 1/4"	8 1/8"	n/a			8"	7"
8"	12"	8 1/2"	13 1/8"	6"	10 3/4"	8 1/2"	8 1/4"	3"	10 1/2"	9 1/2"	3 3/4"	9"	10 1/2"	7 1/2"
10"	15"	12"	14 1/4"	6 3/4"	16 1/2"	11 1/2"	11"	3 5/8"	13 5/8"	14 1/2"	5 3/8"	13 1/4"	15 1/4"	11 1/8"
12"	18 1/2"	14 1/2"	16 1/4"	7"	19"	14 1/2"	12 1/2"	4 1/2"	16 1/2"	17 1/4"	6"	17"	16 1/8"	11 5/8"
14"	22"	17"	21"	9"	20"	17"	17 1/2"	5 1/2"	23"	20 3/4"	7 1/4"	19 1/4"	21 1/4"	14"
15"	22"	17"	24"	10 1/2"	20"	17"	17 1/2"	6 1/8"	22"	20 1/2"	8 3/8"	19 1/2"	21 1/4"	14"
16"	27"	20"	24"	10 1/2"	n/a		17 1/2"	6 1/8"	22"	20 1/2"	8 3/8"	19 1/2"	23"	16"
18"	32 1/2"	23"	28"	12 1/2"	25"	22 1/2"	20"	6 1/2"	24 1/4"	24 1/4"	9 3/4"	19 3/4"	26 3/4"	18 1/8"
20"	39"	25 1/2"	n/a		25"	22 1/2"	25"	8 3/4"	31 3/4"	29 3/4"	11"	28"	28"	21 1/2"
22"	42"	28 1/2"	n/a		n/a		25"	8 3/4"	31 3/4"	29 3/4"	11"	28"	34 1/2"	23 1/4"
24"	42"	28 1/2"	n/a		n/a		25 1/4"	9"	33"	35"	12 3/4"	34 1/2"	31 1/4"	28 1/2"
26"	42"	32"	n/a		n/a		26 1/2"	9 1/2"	33 3/4"	39 1/2"	14 3/4"	38"	35"	24"
28"	46"	34"	n/a		n/a		32"	12 1/2"	40 1/2"	39 1/2"	14 3/4"	38"	37"	28"
30"	46 1/2"	37 1/2"	n/a		n/a		32"	12 1/2"	40 1/2"	n/a			39"	30"
36"	55"	42"	n/a		n/a		n/a			n/a			n/a	

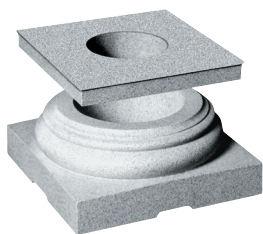

Plaster Ornamental Capitals are coated with boiled linseed oil and turpentine as a temporary protector until they can be primed and coated with at least two coats of oil-base paint on the inside and outside. (If capitals are allowed to gather moisture before painting, peeling is likely to occur and further coating will be futile.) Ornamental Capitals are shipped with a load-bearing plug, which must bear the weight of any load on the column. Specifications and materials are subject to change without notice. Poly/Resin Capitals are load bearing, and do not require plugs.

Exterior and paint-grade interior columns feature polyurethane or fiberglass caps and bases (see charts) to provide crisp, true architectural detail and increased durability. Special-order wood caps and bases are available. Optional aluminum plinths provide an extra measure of protection.



TURNCRAFT

COL

Colonial Column

- READY TO INSTALL
- WATER-REPELLENT TREATMENT
- AVAILABLE IN 6", 8", 10", AND 12"
- IN STOCK FOR IMMEDIATE SHIPMENT
- READY TO PRIME AND PAINT
- WOOD CAPS AND BASES AVAILABLE FOR INTERIOR USE
- POLYURETHANE CAPS AND BASES AVAILABLE FOR EXTERIOR USE
- TREATED WITH WOODLIFE® 111

PRECISION CRAFTSMANSHIP

Turncraft Wood Colonial columns begin with the milling of finger-jointed or solid staves to exacting dimension. The staves are then assembled into a raw shaft using the strongest Type-I waterproof glue. Torque bands are wrapped around the shaft applying 90 to 100 pounds of pressure per square inch, transforming the individual staves into a single unit, ready for precision turning.

TREATED AND PROTECTED WITH WOODLIFE® 111

Non-primed wood Colonial paint grade exterior shafts (except redwood or cedar) are fully immersed in Woodlife® 111 wood preservative. Woodlife® 111 is formulated to protect against staining and decaying fungi, to control shrinking, swelling, end checking, splitting, grain raising, and warping for maximum compatibility with paint, primers, and topcoats. Woodlife® 111 also conforms to Industrial Standard I.S. 4-00, is approved by the N.W.W.D.A., and meets all current and proposed government standards.

UPON REQUEST:

Priming is applied in two coats, using a specially formulated primer developed exclusively for Turncraft. The column is sanded before each coat.

Asphalt coating of the shaft interior is applied to the bottom three feet of the shaft.

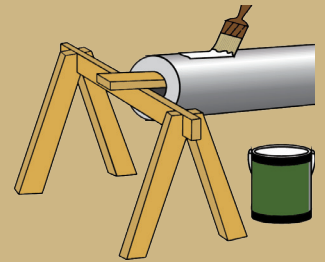

PLAN TYPES

Colonial columns are available in the following plan types. Please specify when you order. Columns other than Plan Type A are not load bearing. Split or reassembled columns are not load bearing.



Colonial
Tapered
Round
Smooth



Colonial
Tapered
Round
Fluted



Colonial
Non-Tapered
Round
Smooth

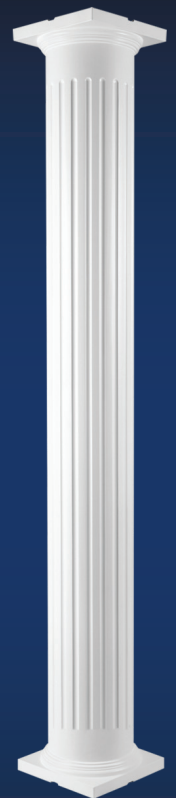

Colonial
Non-Tapered
Round
Fluted

COLONIAL TAPERED COLUMN SPECIFICATIONS

Nominal shaft diameter *	Available heights	Shaft Dimensions				Fluting Dimensions			Maximum Load (pounds) Capacity
		Outside diameter		Inside diameter		Number of flutes	Flutes width	Flute length (A)	
		Bottom	Top	Bottom	Top				
6"	6'	5 5/8"	4 1/4"	3"	1 3/4"	15	1/2"	4'-2"	2,095 lb.
	8'							6'-2"	
	10'							8'-2"	
	12'							10'-2"	
8"	6'	7 5/8"	6 1/4"	5"	3 1/2"	15	7/8"	4'-2"	3,258 lb.
	8'							6'-2"	
	10'							8'-2"	
	12'							10'-2"	
10"	6'	9 5/8"	8 1/4"	7 1/8"	5 1/2"	18	7/8"	4'-2"	4,268 lb.
	8'							6'-2"	
	10'							8'-2"	
	12'							10'-2"	
12"	6'	11 5/8"	10 1/4"	9"	7 1/2"	20	7/8"	4'-2"	5,173 lb.
	8'							6'-2"	
	10'							8'-2"	
	12'							10'-2"	

* Shaft net diameters are 3/8" less than nominal.

** For wood columns, inside sizes are based on the inside diameter of the polyurethane cap. Other caps (wood and ornamental capitals) have different sizes and these numbers will not apply.

Column diameter	Tapered **	
	Inside round	Inside square
6"	1 1/2"	1 1/16"
8"	3"	2 1/4"
10"	5"	3 5/8"
12"	7"	5"

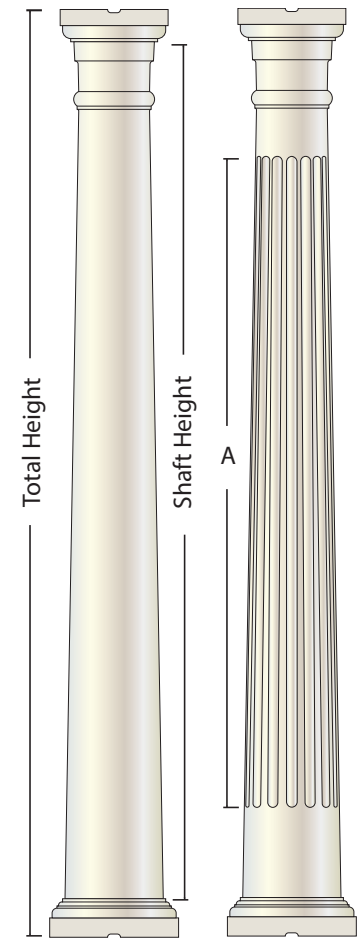
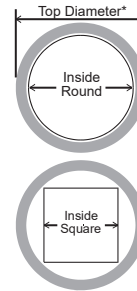

Columns from 14" to 24" diameter are available. Call for more information.

Turncraft manufactures a full selection of Colonial design columns in finger-joint western pine. Other species may be available upon request.

COLONIAL NON-TAPERED COLUMN SPECIFICATIONS

Nominal shaft diameter *	Available heights	Shaft Dimensions		Fluting Dimensions			Maximum Load (pounds) Capacity
		Outside diameter	Inside diameter	Number of flutes	Flutes width	Flute length (A)	
6"	6'	5 5/8"	3"	15	1/2"	4'-10"	2,095 lb.
	8'					6'-10"	
	10'					8'-10"	
8"	6'	7 5/8"	5"	15	7/8"	4'-10"	3,258 lb.
	8'					6'-10"	
	10'					8'-10"	
10"	6'	9 5/8"	7 1/8"	18	7/8"	4'-10"	4,268 lb.
	8'					6'-10"	
	10'					8'-10"	
12"	6'	11 5/8"	9"	20	7/8"	4'-10"	5,173 lb.
	8'					6'-10"	
	10'					8'-10"	

* Shaft net diameters are 3/8" less than nominal.

** For wood columns, inside sizes are based on the inside diameter of the polyurethane cap. Other caps (wood and ornamental capitals) have different sizes and these numbers will not apply.

Column diameter	Non-tapered **	
	Inside round	Inside square
6"	2 5/8"	1 7/8"
8"	4 5/8"	3 1/8"
10"	6 5/8"	4 3/4"
12"	8 5/8"	6"

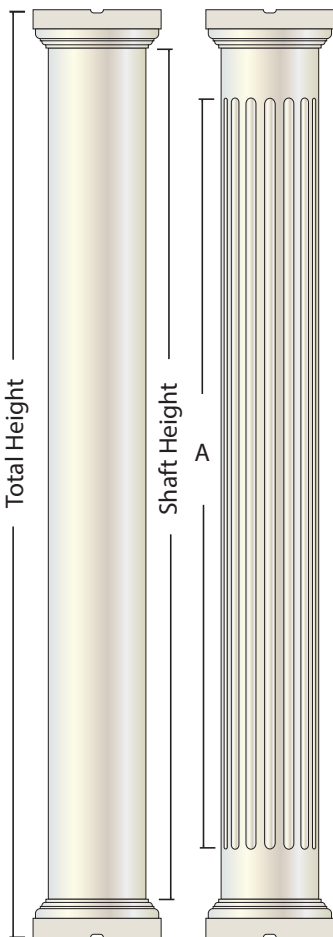
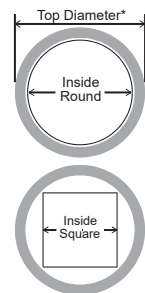

Actual lengths of the flutes for standard configurations are shown in the accompanying tables.

The extra few inches above the base allow the installer to adjust heights as needed to accommodate the variations in porch heights and slopes. Custom flute lengths are available upon request, for the same price as standard fluted columns. Fluting typically ends 4" from the base on custom fluted columns. If using standard height columns with custom height columns, it is best to order the standard height columns custom fluted as well to match the 4" bottom spacing.

POLYURETHANE CAP AND BASE

Column nominal diameter *	Tapered & Non-tapered Polyurethane Base					Tapered Polyurethane Cap					Non-tapered Polyurethane Cap				
	Plinth		Base round		Base height	Cap round		Abacus		Cap height	Cap Round		Abacus		Cap height
	A	B	C	D		E	F	G	H		I	J	K	L	
6"	8 1/8"	1 7/16"	6 1/8"	1 7/16"	2 7/8"	5 1/8"	1 3/16"	6 3/4"	1 1/4"	2 7/16"	6 1/8"	1 7/16"	8 1/8"	1 7/16"	2 7/8"
8"	10"	1 7/16"	8"	1 7/16"	2 7/8"	6 3/4"	1 3/16"	8 3/4"	1 1/4"	2 7/16"	8"	1 7/16"	10"	1 7/16"	2 7/8"
10"	12"	1 7/16"	10"	1 7/16"	2 7/8"	8 7/8"	1 1/16"	10 1/2"	1 7/16"	2 7/8"	10"	1 7/16"	12"	1 7/16"	2 7/8"
12"	14"	1 7/16"	12"	1 7/16"	2 7/8"	10 3/8"	1 1/16"	12"	1 7/16"	2 7/8"	12"	1 7/16"	14"	1 7/16"	2 7/8"

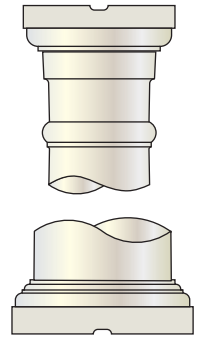
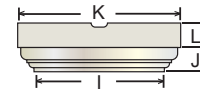
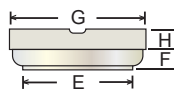
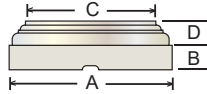

WOOD CAP AND BASE

Column nominal diameter *	Tapered & Non-tapered Wood Base					Tapered Wood Cap					Non-tapered Wood Cap				
	Plinth		Base round		Base height	Cap round		Abacus		Cap height	Cap Round		Abacus		Cap height
	A	B	C	D		E	F	G	H		I	J	K	L	
6"	8 1/8"	1 1/2"	6 1/8"	1 1/2"	3"	5 1/8"	1 1/4"	6 3/4"	1 1/4"	2 1/2"	6 1/8"	1 1/2"	8 1/8"	1 1/2"	3"
8"	10"	1 1/2"	8"	1 1/2"	3"	6 3/4"	1 1/4"	8 3/4"	1 1/4"	2 1/2"	8"	1 1/2"	10"	1 1/2"	3"
10"	12"	1 1/2"	10"	1 1/2"	3"	8 7/8"	1 1/2"	10 3/8"	1 1/2"	3"	10"	1 1/2"	12"	1 1/2"	3"
12"	14"	1 1/2"	12"	1 1/2"	3"	10 3/8"	1 1/2"	12"	1 1/2"	3"	12"	1 1/2"	14"	1 1/2"	3"

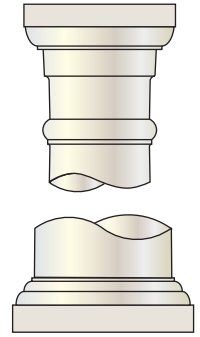
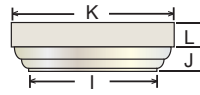
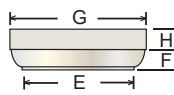
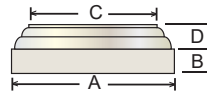

ORNAMENTAL CAPITALS FOR ROUND TAPERED COLONIAL COLUMNS



Nominal bottom diameter	Empire				Empire with Necking				Greek Angular Ionic			
	Capital height	Abacus width	Scroll width	Height adjust	Capital height	Abacus width	Scroll width	Height adjust	Capital height	Abacus width	Scroll width	Height adjust
6"	2 1/2"	7 1/2"	6 3/4"	-4 3/8"	5"	7 1/2"	6 3/4"	-1 1/4"	2 3/4"	7 1/2"	6 3/4"	-4 1/8"
8"	3 3/4"	10"	9"	-3 1/8"	7 3/4"	10"	9"	+1 1/2"	3 5/8"	9 1/4"	9"	-3 1/4"
10"	5 1/4"	13 1/2"	12 1/4"	-2"	10"	13 1/2"	12 1/4"	+3 3/8"	5 1/8"	14 1/4"	13 3/4"	-2 1/8"
12"	6 1/4"	18"	17"	-1"	11"	18"	17"	+4 3/8"	6"	17 1/4"	17"	-1 1/4"

Nominal bottom diameter	Greek Erectheum				Greek Erectheum with Necking				Modern Composite		
	Capital height	Abacus width	Scroll width	Height adjust	Capital height	Abacus width	Scroll width	Height adjust	Capital height	Abacus width	Height adjust
6"	3 1/4"	6 3/4"	8 1/2"	-3 5/8"	n/a				6 1/2"	7 1/2"	+1/4"
8"	3 3/4"	7 3/4"	11 3/4"	-3 1/8"	5 3/4"	7 3/4"	11 3/4"	-1/2"	8 1/2"	10 3/4"	+2 1/4"
10"	5 1/4"	10 1/2"	15"	-2"	7 1/2"	10 1/2"	15"	+7/8"	11 1/2"	16 1/2"	+4 7/8"
12"	6 1/4"	14 1/2"	21"	-1"	8 1/2"	12"	17 1/4"	+1 7/8"	12 1/4"	16 1/2"	+5 5/8"

Nominal bottom diameter	Roman Corinthian			Roman Doric Ornamental			Roman Ionic				Scamozzi				Temple of Winds		
	Capital height	Abacus width	Height adjust	Capital height	Abacus width	Height adjust	Capital height	Abacus width	Scroll width	Height adjust	Capital height	Abacus width	Scroll width	Height adjust	Capital height	Abacus width	Height adjust
6"	5 3/4"	7 7/8"	-1/2"	4"	8 3/4"	-2 1/4"	2 1/4"	6 1/8"	8 1/16"	-4 5/8"	2 1/2"	6 1/2"	5 1/4"	-4 3/8"	6"	6"	-1/4"
8"	8"	9 3/8"	+1 3/4"	4 1/2"	10 1/2"	-1 3/4"	3"	8 1/4"	10 1/2"	-3 7/8"	2 7/8"	10"	8"	-4"	7"	8"	+3/4"
10"	11"	13"	+4 3/8"	6"	14 1/4"	-3/8"	3 5/8"	10 1/2"	13 1/2"	-3 3/8"	3 1/2"	11"	9 3/8"	-3 3/4"	10"	13 5/8"	+3 3/8"
12"	13 7/8"	17 3/4"	+7 1/4"	7"	16 1/4"	+3/8"	4 1/2"	12 1/2"	16 1/2"	-2 3/4"	4 7/8"	16 3/8"	15 5/8"	-2 3/8"	11 3/8"	16 1/2"	+4 3/4"

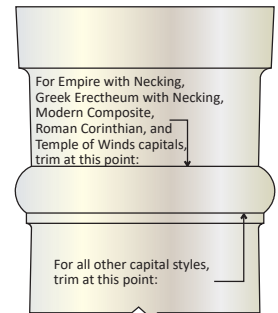



TURNCRAFT

SWC

Square Wood Columns

- READY TO INSTALL
- STRUCTURAL, LOAD-BEARING
- POST DEFENSE™ SEALER
- FACTORY SANDED AND PRIMED FOR EASY FINISHING
- EASY TO ATTACH RAILINGS
- INCLUDES MULTIPLE CAP AND BASE OPTIONS
- DESIGNED FOR INTERIOR OR EXTERIOR USE
- LIMITED LIFETIME WARRANTY

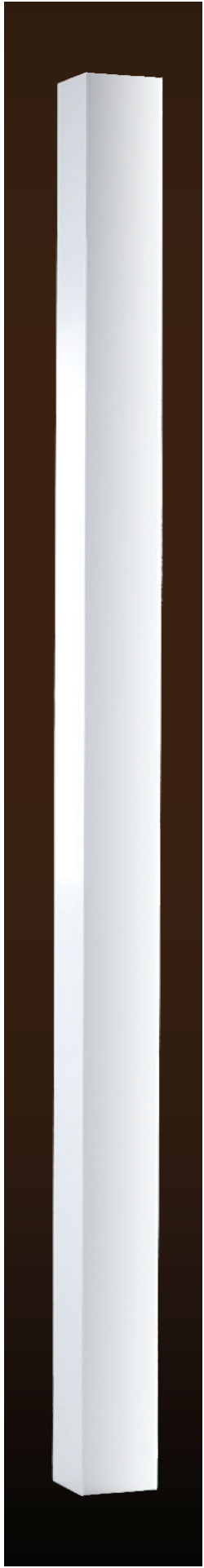

Nominal	NET	Shaft height	Load capacity	Item #
4"	3 3/16"	8'	1,000	D8248A
		9'	1,000	D8249A
		10'	1,000	D8370A
5"	4 3/16"	8'	3,000	D8258A
		9'	3,000	D8259A
		10'	3,000	D8375A
6"	5 3/16"	8'	5,800	D8268A
		9'	5,800	D8269A
		10'	5,800	D8380A
8"	7"	8'	7,000	D0808A
		9'	7,000	D0809A
		10'	7,000	D0810A
10"	9"	8'	8,000	D1008A
		9'	8,000	D1009A
		10'	8,000	D1010A

ADDED PROTECTION
Special formulated end-seal added to the bottom of each column.

POST SAVER™
Designed and engineered to work perfectly with square columns.
(Required for warranty)

LIMITED
LIFETIME
COLUMN
DEFENSE™
WARRANTY

MISSION CAP & BASE

Size	Width	Height	Item #
4"	4 5/8"	3"	PW04
5"	5 5/8"	3"	PW05
6"	6 5/8"	3"	PW06
8"	8 1/4"	3"	PW08
10"	10 1/4"	3"	PW10

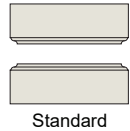

CROWN CAP & BASE

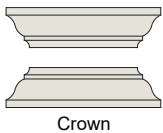

Size	Width	Height	Item #
6"	11"	3"	PW0406
8"	13"	3"	PW0408
10"	15"	3"	PW0410



MISSION CAP & BASE

Size	Width	Height	Item #
6"	7"	5 1/4"	PW1606
8"	9"	5 1/4"	PW1608
10"	11"	5 1/4"	PW1610

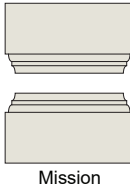

POSTSAVER™ (required for warranty)

Size	Height	Item #
4"	3/4"	A2101
5"	3/4"	A2102
6"	3/4"	A2103
8"	3/4"	PW2104
10"	3/4"	PW2105

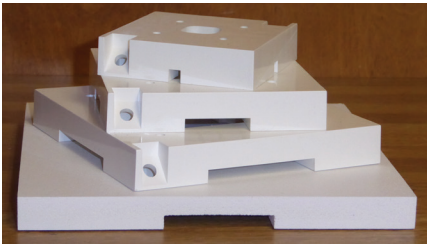

PRAIRIE CAP & BASE

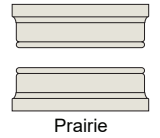

Size	Width	Height	Item #
6"	7 1/2"	3 1/4"	PW1206
8"	9 1/2"	3 1/4"	PW1208
10"	11 1/2"	3 1/4"	PW1210

TUSCAN CAP & BASE

Size	Width	Height	Item #
6"	7 3/8"	3 1/4"	PW0206
8"	10 3/4"	4 1/4"	PW0208
10"	12 7/8"	5 1/4"	PW0210

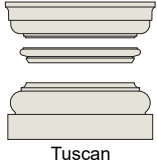



TURNCRAFT

WPP *Post Defense*

- REAL WOOD TURNINGS
- SANDED AND PRIMED FOR EASY FINISHING
- SPECIAL SEALER APPLIED TO BOTTOM OF POSTS
- POST-SAVER™ FASTENERS
- POST DEFENSE™ LIMITED LIFETIME WARRANTY
- READY TO PAINT
- 4", 5" AND 6" SIZES
- 8', 9' AND 10' LENGTHS



COLONIAL PORCH POST

Bottom width	Shaft height	Load capacity	Item number
4"	8'	1,000	D3148A
	9'	1,000	D3049A
	10'	1,000	D3410A
5"	8'	3,000	D3158A
	9'	3,000	D3059A
	10'	3,000	D3510A
6"	8'	5,800	D3168A
	9'	5,800	D3069A
	10'	5,800	D3610A

CHAMFERED PORCH POST

Bottom width	Shaft height	Load capacity	Item number
5"	8'	3,000	D8258AC
	9'	3,000	D8259AC
	10'	3,000	D8375AC
6"	8'	5,800	D8268AC
	9'	5,800	D8269AC
	10'	5,800	D8380AC

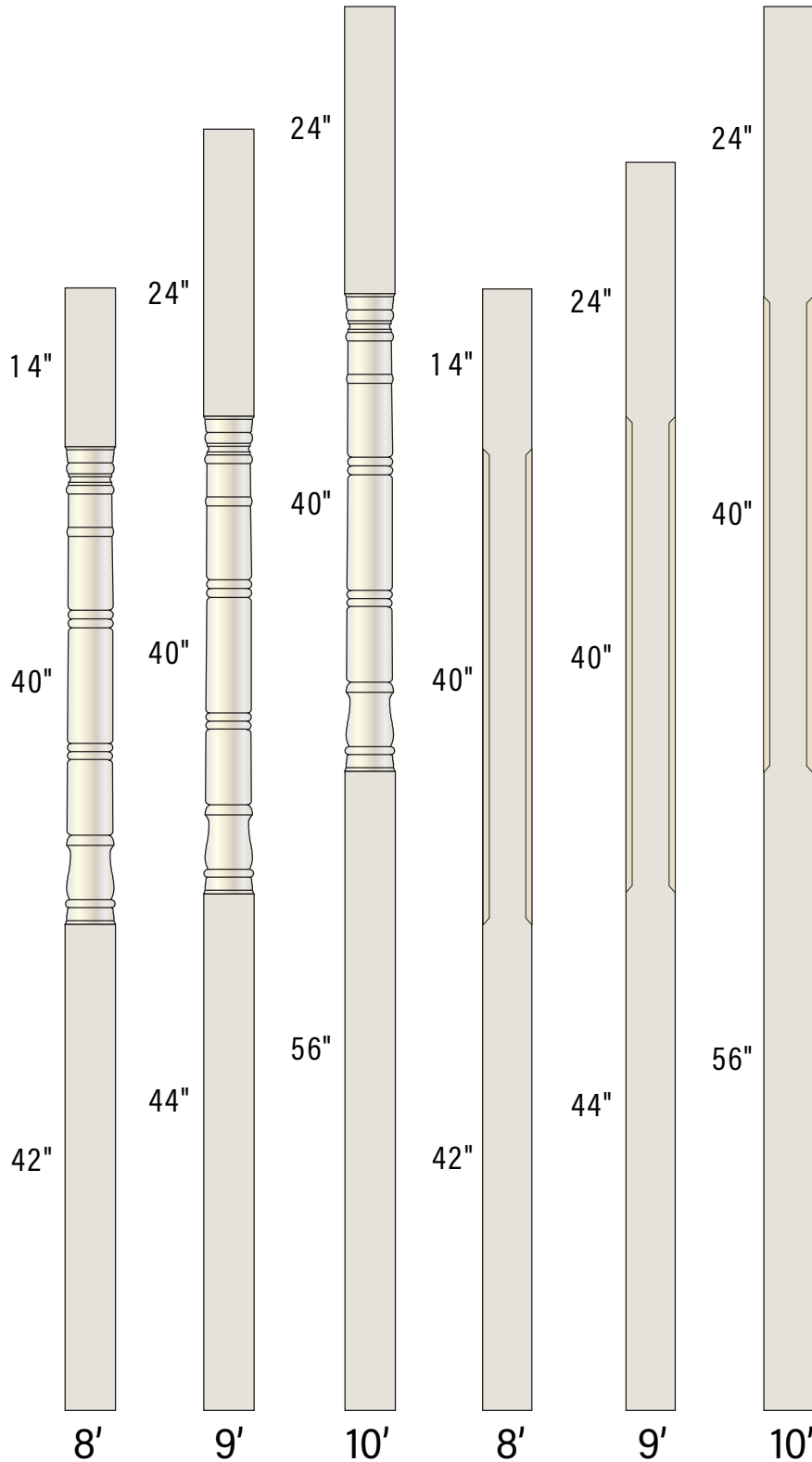

Turncraft.com

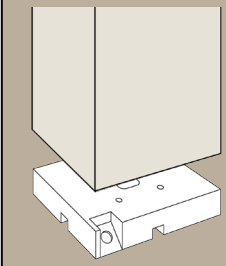

POST SAVER™
Designed and engineered to work perfectly with square columns. (Required for warranty)

POSTSAVER™ (required for warranty)

Size	Height	Item #
4"	3/4"	A2101
5"	3/4"	A2102
6"	3/4"	A2103



POST TRIM KIT
The new PVC porch post Trim kit is designed to wrap around the porch post and mounting (Post Saver™, plinth, etc.) for a finished look.



Visit Turncraft's Website

COLUMN BUILDER PDF CREATOR

Our interactive column builder will allow you to choose the column, capital and base of your choice. When you have designed the column you can save it to a PDF for printing. Take the PDF to your local Turncraft distributor for pricing and availability.

FRP
TURNCRAFT

COLUMN
Type: Poly-Classic® FRP Columns
Style: Tapered Round
Shaft Nominal Bottom Diameter: 10"
Total Height: 10'
Outer/Inner Diameters:
Bottom Net Outer: 9-11/16"
Bottom Net Inner: 8-3/8"
Top Net Outer: 8-9/16"
Top Net Inner: 7-3/4"
Max Load Capacity: 14,000 lbs
Flutes Number: 24
Flutes Width: 7/8"

PLAN:
A

CAP:
Style: Tuscan
Abacus Width (A): 12-5/32"
Capital Height (B): 3-9/16"

BASE:
Style: Tuscan
Plinth Width (A): 13-1/2"
Plinth Height (B): 2-3/8"
Total Height (C): 5-1/4"

FLAME GUARD

This drawing illustrates the style of column you have selected, but may not represent the actual scale/size/proportions you've chosen.
For additional or custom sizes call us at 800-423-3311

Column Builder is exclusive to Turncraft Columns
©2007-2019 Turncraft, All Rights Reserved

Column Builder also available for all IOS phones and tablets.



PHOTO GALLERY

- View Turncraft products installed in various locations.

LITERATURE BROWSER

- Quick access to all the literature offered on Turncraft website.

ARCHITECT'S CORNER

- Specifications and instructions for the architect.

PRODUCTS

You can select any of our product lines by clicking on the desired column.

- Turncraft Architectural Wood Columns
- Poly-Classic® FRP Columns
- DuraStone™ Columns
- DuraGlass™ Columns
- Craftsman Columns
- Porch Post
- Wood Colonial Columns
- Wood Square Columns
- Wood Porch Posts

Clicking on the product tab will pull up all the information available for that particular product.

ADDITIONAL INFORMATION

All of the information available in PDF format will be available here for your selection. Simply click on the desired PDF to view, save or print it out.

- Installation instructions
- Warranty information
- Specifications
- Catalog PDF

Turncraft Column Builder App Available in App Store



find us on:



Quality at Every Turn

At Turncraft the quality starts with the materials.

As a division of Cascade Wood Products, we have direct control of the raw materials used in our wood products. Unlike other column manufacturers, our ability to monitor materials at each step of the process ensures every Turncraft wood column will offer both the natural beauty and the quality needed to stand the test of time. Quality control is further improved by using specialized machinery unique to each product line. By keeping our manufacturing facilities separate, we can better monitor, control and improve how well and how efficiently all of our products are constructed.



Thoughtful design, exceptional materials and fine workmanship.

CREATING BEAUTY IS AN EXACTING PROCESS.

For Architectural Series columns, finger-jointed* or solid staves are milled to required dimensions, assembled using the strongest Type-I waterproof glue, then metal-banded for curing. A computer-controlled lathe turns the assembled shaft to the precise taper desired, complete with true architectural entasis. The top is profiled, the entire column is machine sanded and flutes are milled at precise intervals and depths, ending in half-rounds at the top and bottom (except on Greek Doric).

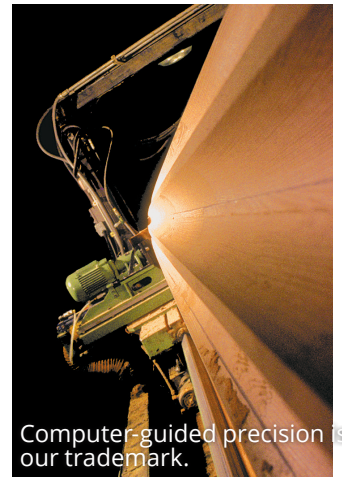

Computer-guided precision is our trademark.

ALTERNATIVE BUILDING MATERIALS.

Turncraft has responded to the growing demand for alternative building materials. In 1994, we introduced our Poly-Classic® line of fiberglass-reinforced polymer (FRP) columns to offer customers a more versatile and durable alternative. In 2005, we added the Poly-Classic® Craftsman line—a popular design made of expanded cellular PVC for easy assembly and virtually maintenance-free performance.

CUSTOM SOLUTIONS.

While Turncraft offers an extremely diverse lineup of products in more sizes and styles, we are also here to serve your imagination. With our access to the finest building materials, if you can dream it we can build it for you.

** Using finger-jointed pieces conserves wood resources, reduces potential for warping and bow, and helps prevent checking or cracking of finished surfaces.*





TURNCRAFT®

Beauty. Value. Performance.

Turncraft's long history of high-quality craftsmanship is reflected in its entire product line, designed to add elegance and value to any building project.

Turncraft is your best source for:

- Poly-Classic® FRP Columns
- Poly-Classic® DuraStone™ Columns
- Poly-Classic® DuraGlass™ Columns
- Poly-Classic® Craftsman Series Columns
- Poly-Classic® Porch Posts
- Turncraft Architectural Columns
- Wood Colonial Columns
- Wood Square Columns
- Wood Porch Posts

For detailed information on Turncraft's complete product line, please visit our website

Turncraft.com

PO Box 2429
White City, Oregon 97503
T 541 826 2911
F 541 826 1393
info@turncraft.com

distributed by:

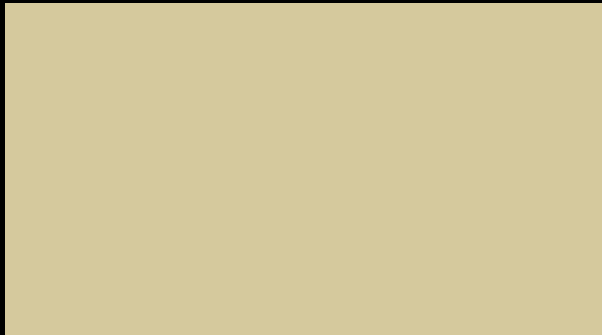

©2017 Turncraft. All rights reserved. Turncraft and Poly-Classic® are registered trademarks of Cascade Wood Products, Inc. Post Defense™ is a trademark of Cascade Wood Products, Inc. All other trademarks mentioned herein are the property of their respective owners. Information and specifications in this catalog are subject to change without notice.

